

22.23

**M** MUEBLES PANAMAR

DISCOVER THE  
DIFFERENCE

descubre la diferencia

[www.panamarmuebles.com](http://www.panamarmuebles.com)

Shoes cases  
Zapatos

Pag. 10-31

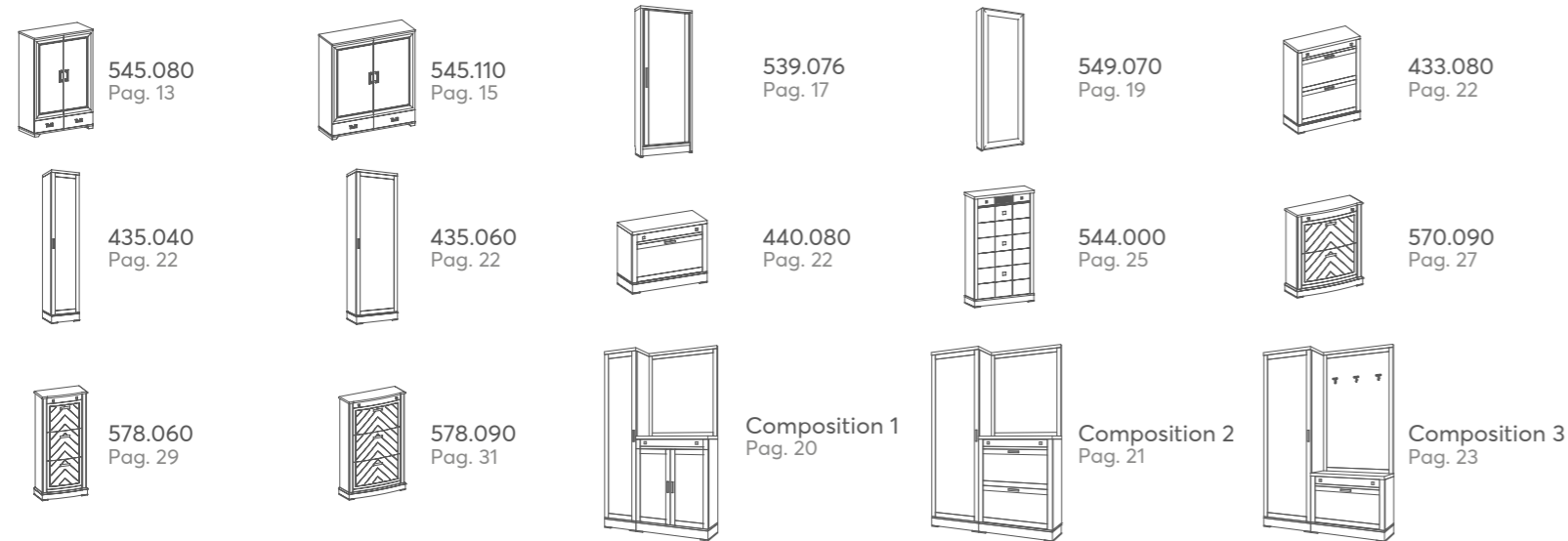

Hall cabinets  
Entradas

Pag. 32-57

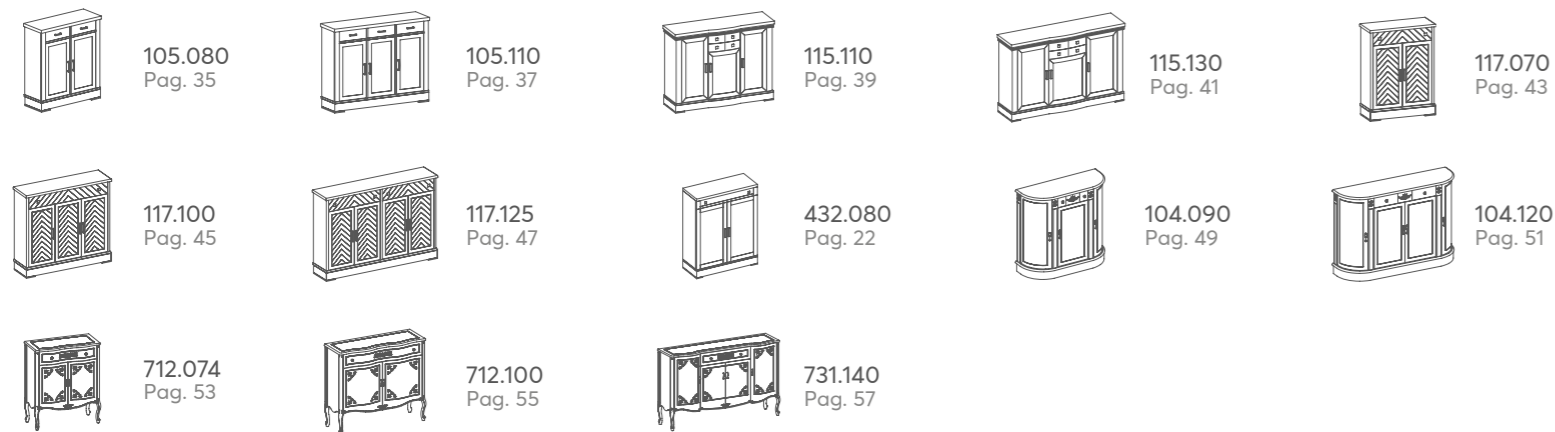

Consoles & pedestal tables  
Consolas y veladores

Pag. 58-67



Mirrors  
Marcos

Pag. 68-71

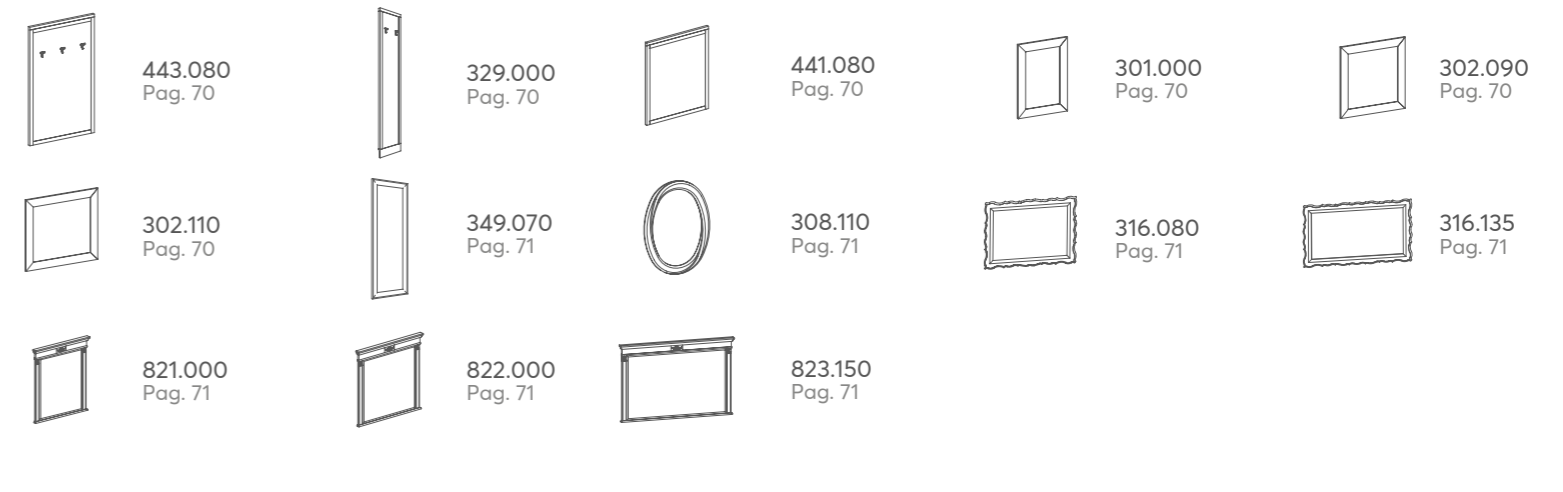

Tv tables  
Módulos Tv

Pag. 72-79



Coffee tables & pedestal tables  
Mesas centro y veladores

Pag. 80-93

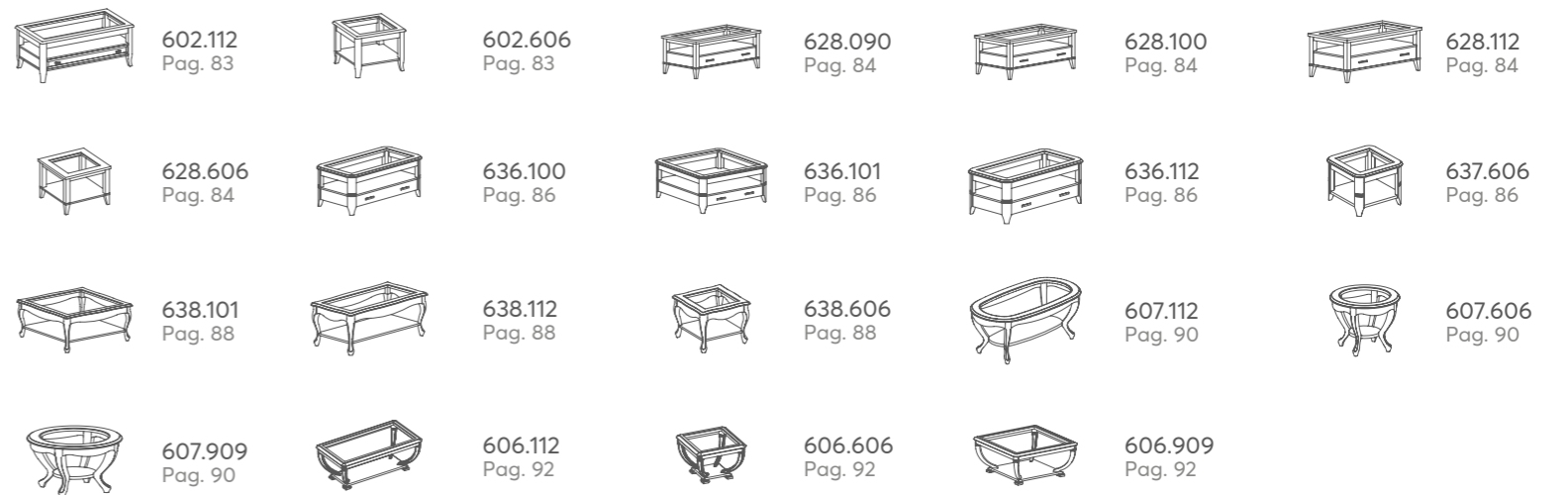

Dining tables  
Mesas comedor

Pag. 94-101



Chairs & armchairs  
Sillas y sillones

Pag. 102-113



Sideboards  
Aparadores

Pag. 114-125



Display cabinets  
Vitrinas

Pag. 126-137

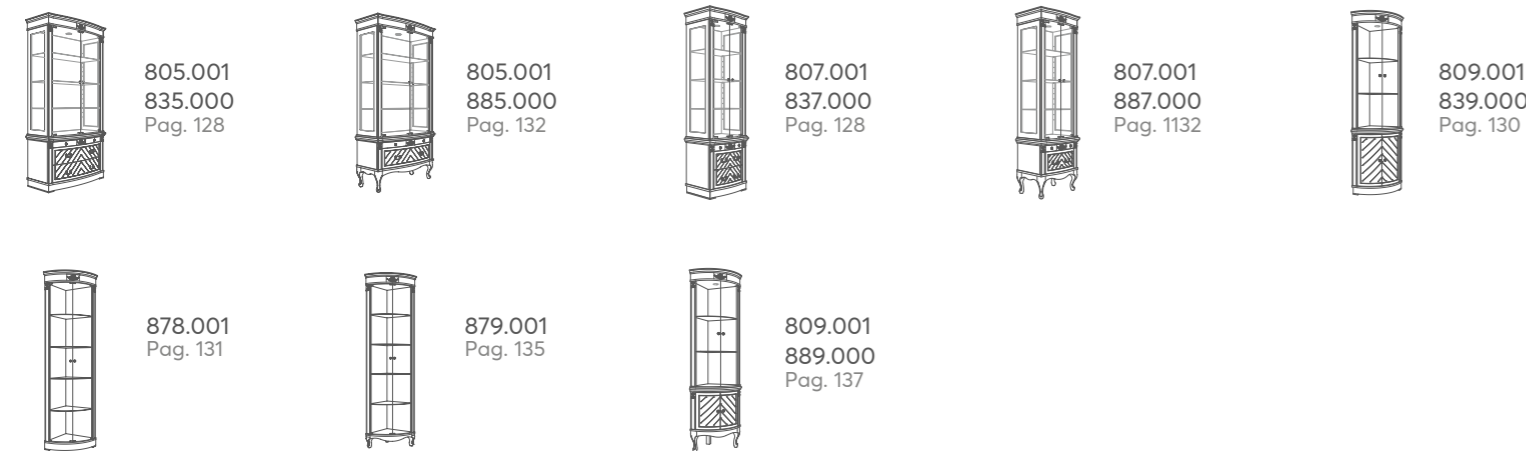

Book cases  
Libreros

Pag. 138-147

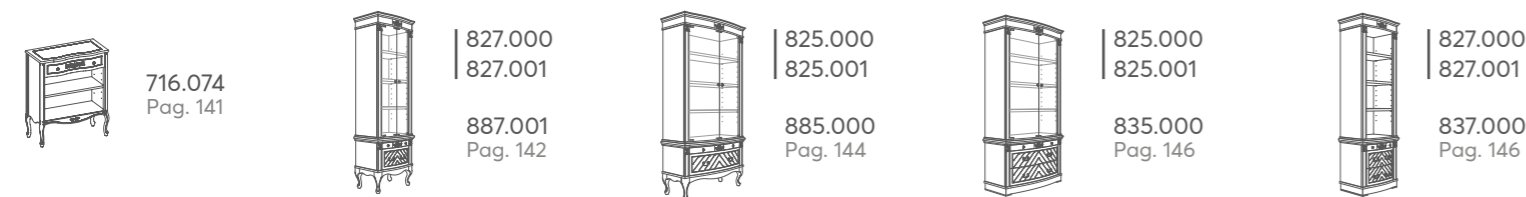

Desks & vanity tables  
Escritorios y tocadores

Pag. 148-161



Chest of drawers & Bedside tables  
C6mодas y mesitas

Pag. 162-187

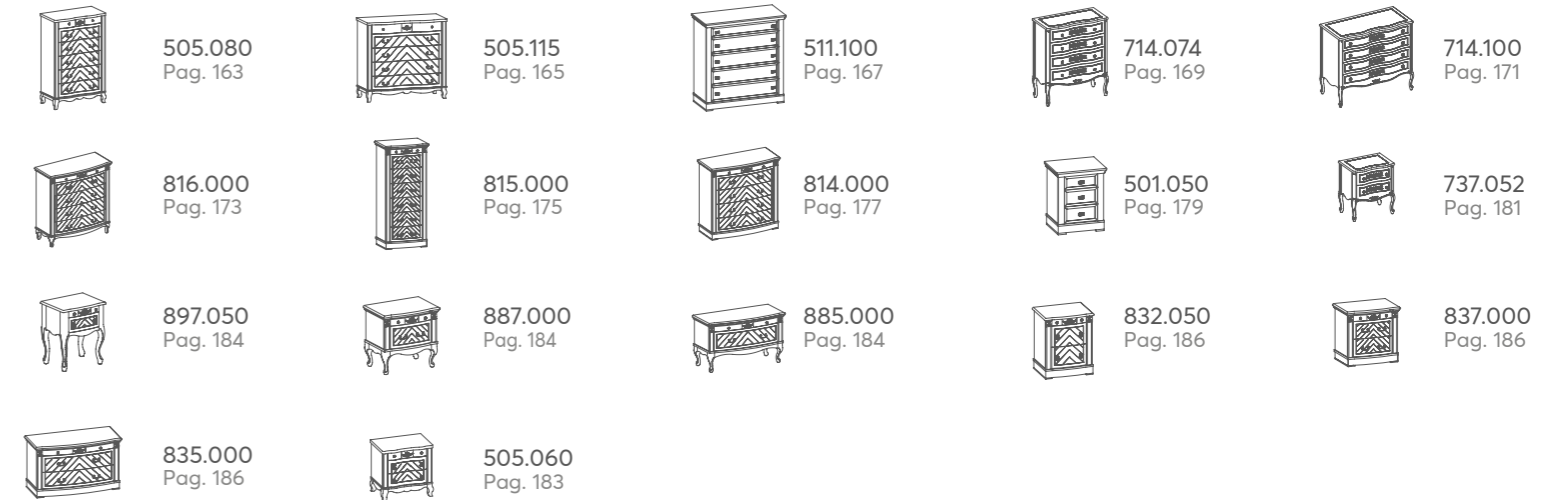

Beds & Wardrobes  
Camas y armarios

Pag. 188-205

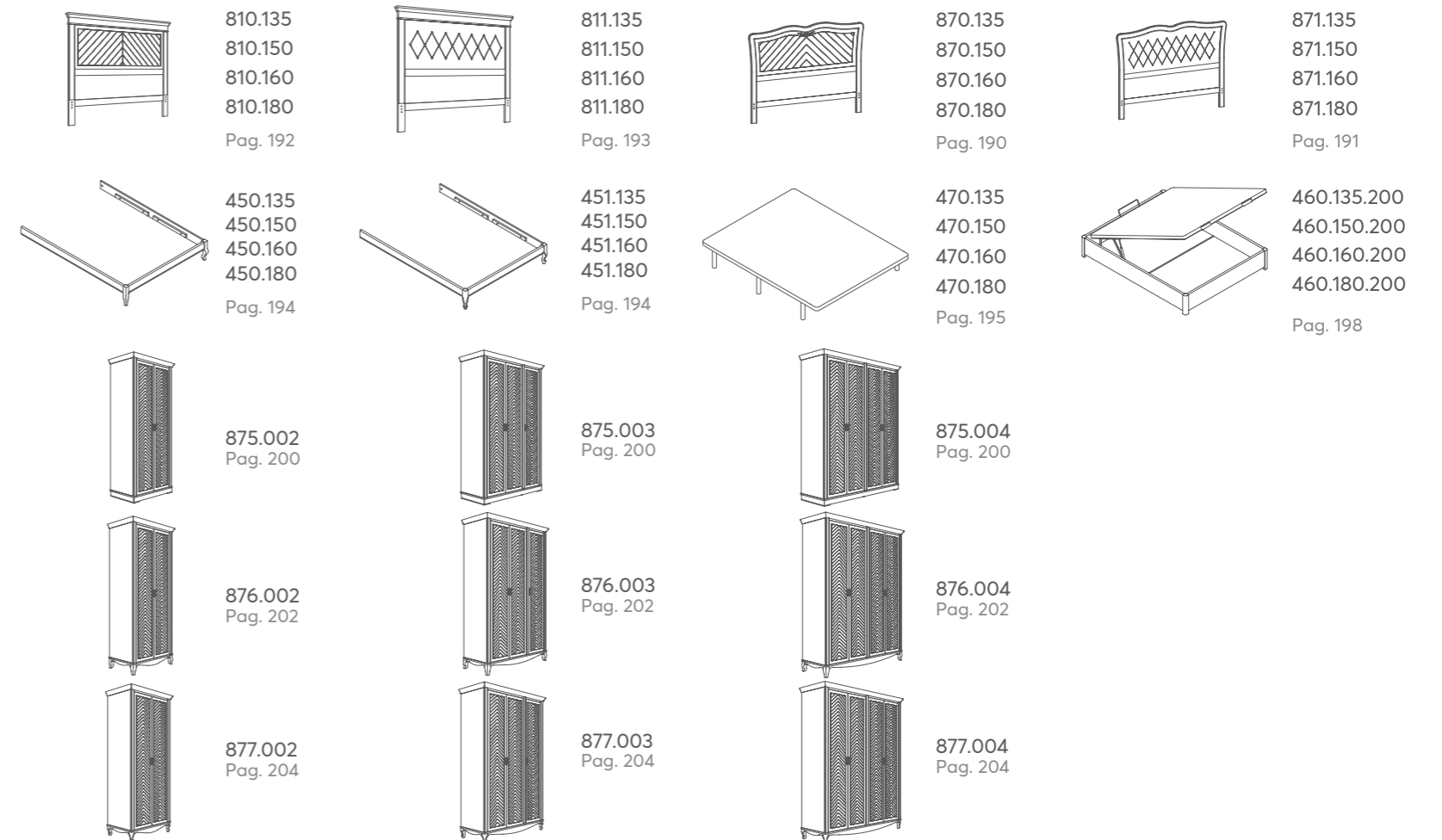



809.001  
Display cabinet  
Vitrina  
pag. 137

889.000  
Module  
Módulo  
pag. 137

807.001  
Display cabinet  
Vitrina  
pag. 132

887.000  
Module  
Módulo  
pag. 132

861.150  
Tv table  
Módulo tv  
pag. 77

805.001  
Display cabinet  
Vitrina  
pag. 132

885.000  
Module  
Módulo  
pag. 132

638.101  
Square table  
Mesa cuadrada  
pag. 88

delicate  
CURVED SHAPES

801.150  
Tv table  
Módulo tv  
pag. 79

807.001  
Display cabinet  
Vitrina  
pag. 128

837.000  
Module  
Módulo  
pag. 128

805.001  
Display cabinet  
Vitrina  
pag. 128

835.000  
Module  
Módulo  
pag. 128

**elegant**  
CLASSIC COLLECTION











SHOES  
CASES  
zapateros



 Additional pack 4 pegs +4,00 points (NOT INCLUDED)  
Pack 4 pinzas adicionales +4,00 puntos (NO INCLUIDO)

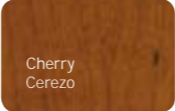
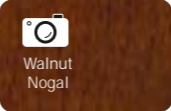

							
123  37 82	545.080 Shoes case Zapatero	24,50	51 kg	0,42 m <sup>3</sup>	x24/30	Cherry Cerezo	Walnut Nogal







Additional pack 6 pegs +6,00 points  
(NOT INCLUDED)  
Pack 6 pinzas adicionales +6,00 puntos  
(NO INCLUIDO)

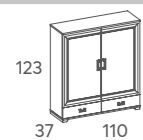

545.110  
Shoes case  
Zapatero

28,00

66 kg

0,58 m<sup>3</sup>

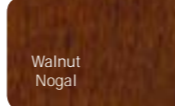
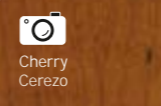

ERGONOMIC PLACEMENT SYSTEM



MOD.



539.076  
Shoes case  
Zapatero

30,50

66 kg

0,41 m<sup>3</sup>

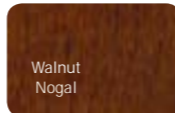
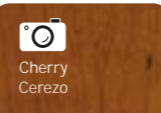

MOD.

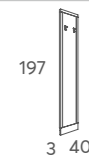

329.000  
Hook panel  
Perchero

11,60

11 kg

0,05 m<sup>3</sup>

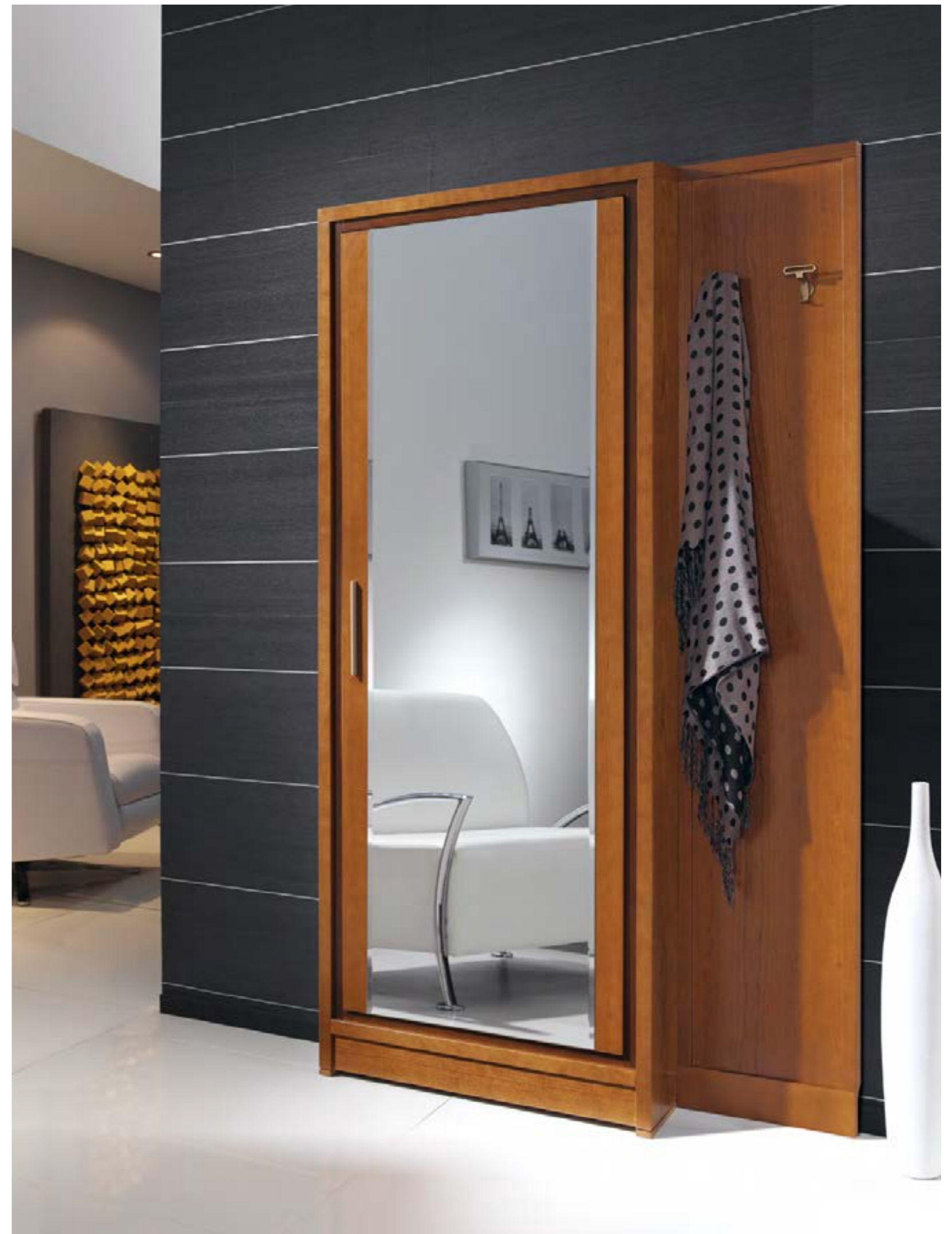
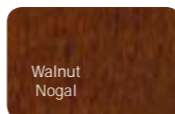
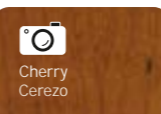

ERGONOMIC PLACEMENT SYSTEM



MOD.

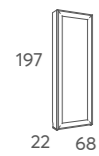

549.070  
Shoes case  
Zapatero

30,50

52 kg

0,36 m<sup>3</sup>

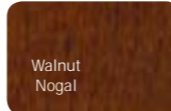
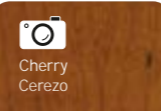

MOD.



329.000  
Hook panel  
Perchero

11,60

11 kg

0,05 m<sup>3</sup>

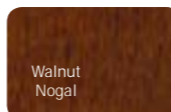
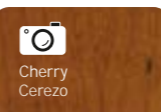



**variety**  
MODULAR COLLECTION





pag.: 20



pag.: 21

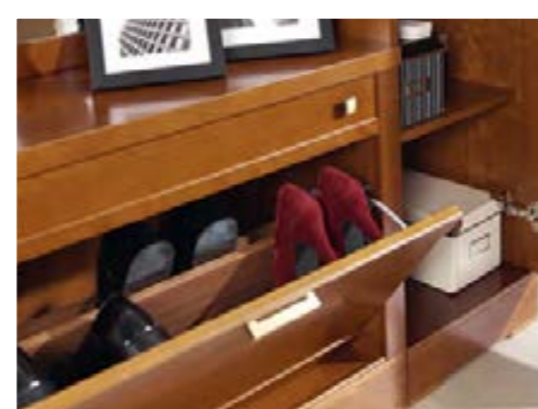

pag.: 23

SHAPES YOUR PERFECT COMPOSITION



 95 3 80	<b>441.080</b> Mirror Marco	8,90	15 kg	0,05 m <sup>3</sup>	 	 Cherry Cerezo	 Walnut Nogal
 134 3 80	<b>443.080</b> Hook panel Perchero	12,90	14 kg	0,07 m <sup>3</sup>	 	 Cherry Cerezo	 Walnut Nogal
 197 3 40	<b>329.000</b> Hook panel Perchero	11,60	11 kg	0,05 m <sup>3</sup>	 	 Cherry Cerezo	 Walnut Nogal
 102 33 80	<b>432.080</b> Hall cabinet Taquillón	20,00	39 kg	0,33 m <sup>3</sup>	  	 Cherry Cerezo	 Walnut Nogal
 102 33 80	<b>433.080</b> Shoes case Zapatero	23,60	40 kg	0,33 m <sup>3</sup>	  	 Cherry Cerezo	 Walnut Nogal
 63 33 80	<b>440.080</b> Shoes case Zapatero	17,50	29 kg	0,21 m <sup>3</sup>	  	 Cherry Cerezo	 Walnut Nogal
 197 33 40	<b>435.040</b> Wardrobe Armario	23,00	45 kg	0,33 m <sup>3</sup>	     	 Cherry Cerezo	 Walnut Nogal
 197 33 60	<b>435.060</b> Wardrobe Armario	26,00	59 kg	0,48 m <sup>3</sup>	     	 Cherry Cerezo	 Walnut Nogal

Additional pack 4 shelves +4,00 points  
 Pack 4 estantes adicionales +4,00 puntos

Additional pack 4 shelves +5,00 points  
 Pack 4 estantes adicionales +5,00 puntos





MOD.

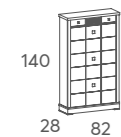

544.000  
Shoes case  
Zapatero

27,80

52 kg

0,40 m<sup>3</sup>



Cherry  
Cerezo

Walnut  
Nogal



100 31 88	570.090 Shoes case Zapatero	28,20	37 kg	0,32 m <sup>3</sup>	x12/14	Cherry Cerezo	Walnut Nogal



110 4 80	308.110 Mirror Marco	15,00	12 kg	0,07 m <sup>3</sup>	OTROS MODELOS PÁG. 70-71 OTHER MODELS IN PAG. 70-71	Cherry Cerezo	Walnut Nogal





MOD.



578.060  
Shoes case  
Zapatero

28,00

37 kg

0,32 m<sup>3</sup>



x12/15



Cherry  
Cerezo



Walnut  
Nogal





MOD.

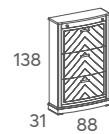
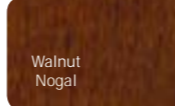
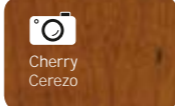

578.090  
Shoes case  
Zapatero

29,60

49 kg

0,46 m<sup>3</sup>

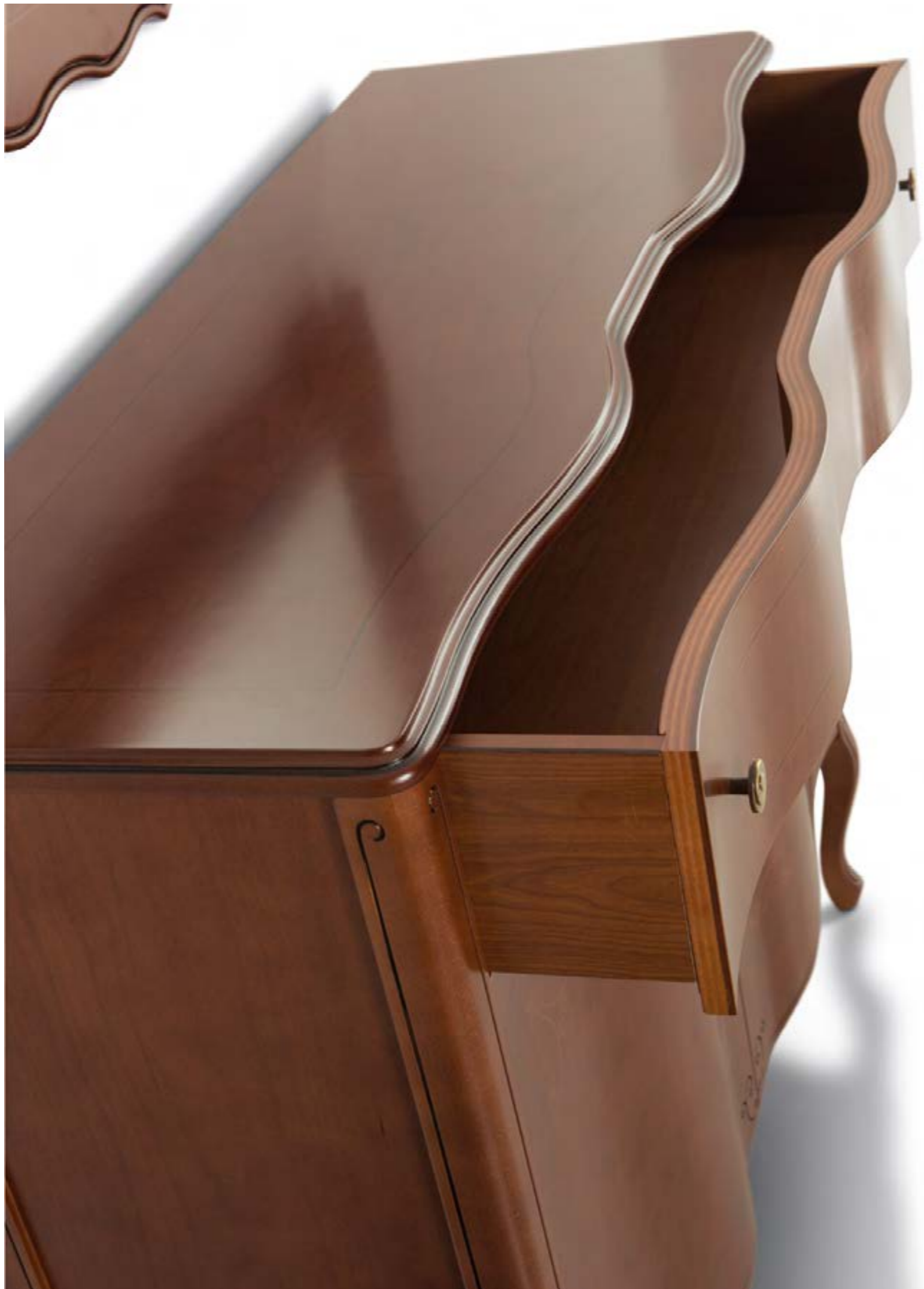

HALL  
CABINETS  
entradas



 86 29 76	105.080 Hall cabinet Taquillón	20,60	35 kg	0,23 m <sup>3</sup>			



 90 3 60	301.000 Mirror Marco	9,00	12 kg	0,03 m <sup>3</sup>			

OTROS MODELOS PÁG. 70-71  
OTHER MODELS IN PAG. 70-71





	MOD.					
 86 29 108	<b>105.110</b> Hall cabinet Taquillón	23,20	50 kg	0,32 m <sup>3</sup>	  x6	Cherry Cerezo            Walnut Nogal
	MOD.					
 90 3 90	<b>302.090</b> Mirror Marco	9,70	15 kg	0,05 m <sup>3</sup>		Cherry Cerezo            Walnut Nogal
					<b>OTROS MODELOS PÁG. 70-71</b> <b>OTHER MODELS IN PAG. 70-71</b>	



	MOD.						
85 34 110	115.110 Hall cabinet Taquillón	29,90	45 kg	0,37 m <sup>3</sup>		Cherry Cerezo	Walnut Nogal



	MOD.						
90 3 90	302.090 Mirror Marco	9,70	15 kg	0,05 m <sup>3</sup>	OTROS MODELOS PÁG. 70-71 OTHER MODELS IN PAG. 70-71	Cherry Cerezo	Walnut Nogal





MOD.

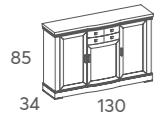

115.130  
Hall cabinet  
Taquillón

32,50

50 kg

0,44 m<sup>3</sup>

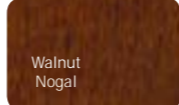
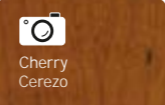

MOD.

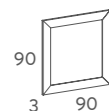

302.090  
Mirror  
Marco

9,70

15 kg

0,05 m<sup>3</sup>

OTROS MODELOS PÁG. 70-71  
OTHER MODELS IN PAG. 70-71

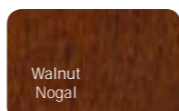
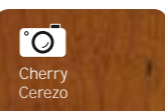

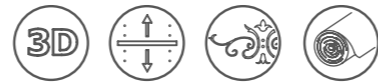

 88 28 66	117.070 Hall cabinet Taquillón	18,40	27 kg	0,20 m <sup>3</sup>	 x2	 x1



 90 3 60	301.000 Mirror Marco	9,00	12 kg	0,03 m <sup>3</sup>	<b>OTROS MODELOS PÁG. 70-71</b> <b>OTHER MODELS IN PAG. 70-71</b>	





MOD.



88  
28 95

117.100  
Hall cabinet  
Taquillón

22,20

36 kg

0,29 m<sup>3</sup>

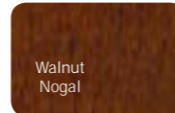
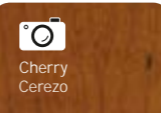

MOD.



90  
3 90

302.090  
Mirror  
Marco

9,70

15 kg

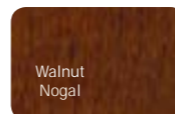
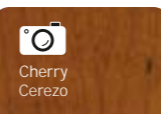

0,05 m<sup>3</sup>

OTROS MODELOS PÁG. 70-71  
OTHER MODELS IN PAG. 70-71



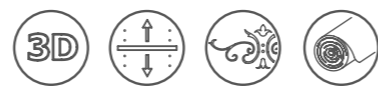

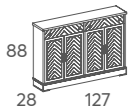

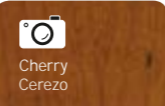
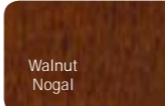
	MOD.							
	117.125 Hall cabinet Taquillón	24,80	48 kg	0,38 m <sup>3</sup>				

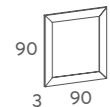
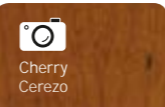

	MOD.							
	302.090 Mirror Marco	9,70	15 kg	0,05 m <sup>3</sup>	<b>OTROS MODELOS PÁG. 70-71</b> <b>OTHER MODELS IN PAG. 70-71</b>			



MOD.



85  
33 88

104.090  
Hall cabinet  
Taquillón

33,10

37 kg

0,30 m<sup>3</sup>

Cherry  
Cerezo



Walnut  
Nogal



MOD.



97  
3 83

821.000  
Mirror  
Marco

13,10

16 kg

0,05 m<sup>3</sup>

OTROS MODELOS PÁG. 70-71  
OTHER MODELS IN PAG. 70-71

Cherry  
Cerezo



Walnut  
Nogal





MOD.



85  
33  
121

104.120  
Hall cabinet  
Taquillón

37,20

49 kg

0,41 m<sup>3</sup>

Cherry  
Cerezo

Walnut  
Nogal



MOD.



97  
3  
101

822.000  
Mirror  
Marco

13,50

20 kg

0,06 m<sup>3</sup>

OTROS MODELOS PÁG. 70-71  
OTHER MODELS IN PAG. 70-71

Cherry  
Cerezo

Walnut  
Nogal

HAND MADE NATURAL MARQUETRIES



MOD.



89  
37 74

712.074  
Hall cabinet-Shoes case  
Taquillón-Zapatero

27,80

29 kg

0,29 m<sup>3</sup>



Cherry  
Cerezo

Walnut  
Nogal



MOD.



80  
3 110

316.080  
Mirror  
Marco

14,50

14 kg

0,04 m<sup>3</sup>

OTROS MODELOS PÁG. 70-71  
OTHER MODELS IN PAG. 70-71

Cherry  
Cerezo

Walnut  
Nogal





MOD.					i			
 89 37 100	<b>712.100</b> Hall cabinet-Shoes case Taquillón-Zapatero	32,70	38 kg	0,38 m <sup>3</sup>	 x2	 x12/13	 Cherry Cerezo	 Walnut Nogal
MOD.					i			
 80 3 110	<b>316.080</b> Mirror Marco	14,50	14 kg	0,04 m <sup>3</sup>	<b>OTROS MODELOS PÁG. 70-71</b> <b>OTHER MODELS IN PAG. 70-71</b>		 Cherry Cerezo	 Walnut Nogal



MOD.

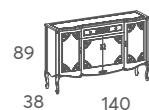

731.140  
Sideboard  
Aparador

41,80

54 kg

0,54 m<sup>3</sup>

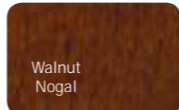
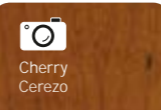

MOD.

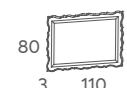

316.080  
Mirror  
Marco

14,50

14 kg

0,04 m<sup>3</sup>

OTROS MODELOS PÁG. 70-71  
OTHER MODELS IN PAG. 70-71

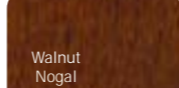
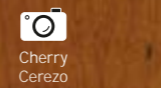



**CONSOLES &  
PEDESTAL TABLES**  
consolas y veladores



MOD.



81  
33 117

164.120  
Console  
Consola

27,90

25 kg

0,36 m<sup>3</sup>

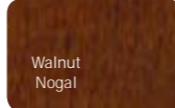
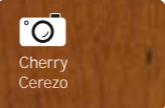

MOD.



80  
3 110

316.080  
Mirror  
Marco

14,50

14 kg

0,04 m<sup>3</sup>

OTROS MODELOS PÁG. 70-71  
OTHER MODELS IN PAG. 70-71

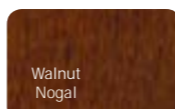





	MOD.		kg	m <sup>3</sup>	i
--	------	--	----	----------------	---

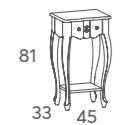

164.050  
Console  
Consola

19,90

14 kg

0,14 m<sup>3</sup>

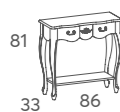
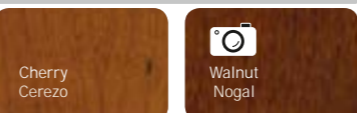

164.090  
Console  
Consola

24,90

20 kg

0,27 m<sup>3</sup>

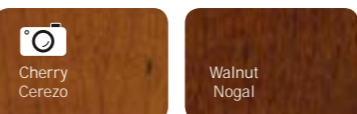

	MOD.		kg	m <sup>3</sup>	i
--	------	--	----	----------------	---

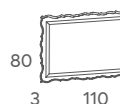

316.080  
Mirror  
Marco

14,50

14 kg

0,04 m<sup>3</sup>

OTROS MODELOS PÁG. 70-71  
OTHER MODELS IN PAG. 70-71

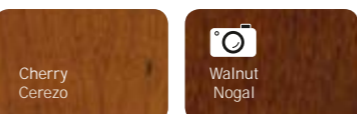



MOD.



172.050  
Pedestal table  
Velador

21,00

14 kg

0,14 m<sup>3</sup>

Cherry  
Cerezo



Walnut  
Nogal

# CHERRY AND WALNUT MARQUETRY TOP



165.050



168.060



169.060



	MOD.		kg.	m <sup>3</sup>		
50 68	165.050 Pedestal table Velador	18,10	13 kg	0,22 m <sup>3</sup>	Cherry Cerezo	Walnut Nogal
60 68	165.060 Pedestal table Velador	19,10	14 kg	0,23 m <sup>3</sup>	Cherry Cerezo	Walnut Nogal
70 68	165.070 Pedestal table Velador	20,40	16 kg	0,24 m <sup>3</sup>	Cherry Cerezo	Walnut Nogal
50 68	168.050 Pedestal table Velador	18,10	13 kg	0,22 m <sup>3</sup>	Cherry Cerezo	Walnut Nogal
60 68	168.060 Pedestal table Velador	19,10	14 kg	0,23 m <sup>3</sup>	Cherry Cerezo	Walnut Nogal
70 68	168.070 Pedestal table Velador	20,40	16 kg	0,24 m <sup>3</sup>	Cherry Cerezo	Walnut Nogal
50 62	169.050 Pedestal table Velador	16,80	8 kg	0,14 m <sup>3</sup>	Cherry Cerezo	Walnut Nogal
60 62	169.060 Pedestal table Velador	17,50	10 kg	0,15 m <sup>3</sup>	Cherry Cerezo	Walnut Nogal



THREE DIFERENT FORMS OF CARVED LEGS



INFO PAG. 71 (Mod. 349.070)

MIRRORS &  
HOOK PANEL  
espejos y percheros



MOD.		3D	kg	m <sup>3</sup>	Cherry Cerezo	Walnut Nogal
134 3	80	443.080	12,90	14 kg	0,07 m <sup>3</sup>	



MOD.		3D	kg	m <sup>3</sup>	Cherry Cerezo	Walnut Nogal
197 3	40	329.000	11,60	11 kg	0,05 m <sup>3</sup>	



MOD.		3D	kg	m <sup>3</sup>	Cherry Cerezo	Walnut Nogal
95 3	80	441.080	8,90	15 kg	0,05 m <sup>3</sup>	



MOD.		3D	kg	m <sup>3</sup>	Cherry Cerezo	Walnut Nogal
90 3	60	301.000	9,00	12 kg	0,03 m <sup>3</sup>	
90 3	90	302.090	9,70	15 kg	0,05 m <sup>3</sup>	
90 3	110	302.110	11,10	18 kg	0,06 m <sup>3</sup>	



MOD.		3D	kg	m <sup>3</sup>	Cherry Cerezo	Walnut Nogal
196 4	68	349.070	17,80	25 kg	0,09 m <sup>3</sup>	



MOD.		3D	kg	m <sup>3</sup>	Cherry Cerezo	Walnut Nogal
110 4	80	308.110	15,00	12 kg	0,07 m <sup>3</sup>	



MOD.		3D	kg	m <sup>3</sup>	Cherry Cerezo	Walnut Nogal
80 3	110	316.080	14,50	14 kg	0,04 m <sup>3</sup>	
80 3	135	316.135	16,30	21 kg	0,06 m <sup>3</sup>	



MOD.		3D	kg	m <sup>3</sup>	Cherry Cerezo	Walnut Nogal
97 3	83	821.000	13,10	16 kg	0,05 m <sup>3</sup>	
97 3	101	822.000	13,50	20 kg	0,06 m <sup>3</sup>	
97 3	150	823.150	19,20	23 kg	0,16 m <sup>3</sup>	

TV TABLES  
módulos tv



FUNCTIONAL AND STYLISH FURNITURE



MOD.

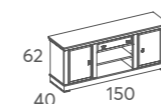

211.150  
Tv table  
Módulo tv

26,90

51 kg

0,43 m<sup>3</sup>





CURVED AND CARVED FRONT

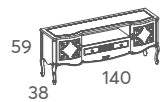

701.140  
Tv table  
Módulo tv

33,00 30 kg 0,37 m<sup>3</sup>



# Elegancia clásica para crear ambientes exclusivos

Classic elegance to create  
exclusive environments



SOFT AND ELEGANT TV TABLE

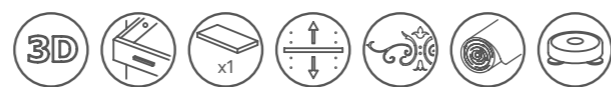

MOD.

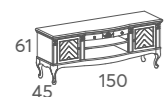

861.150  
Tv table  
Módulo tv

36,00

42 kg

0,47 m<sup>3</sup>

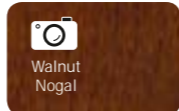
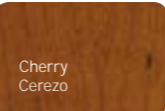





MOD.

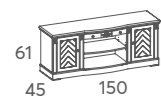

801.150  
Tv table  
Módulo tv

33,00

53 kg

0,47 m<sup>3</sup>

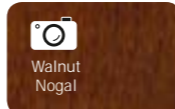
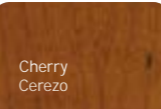

**tradition**  
STYLISH TV TABLE

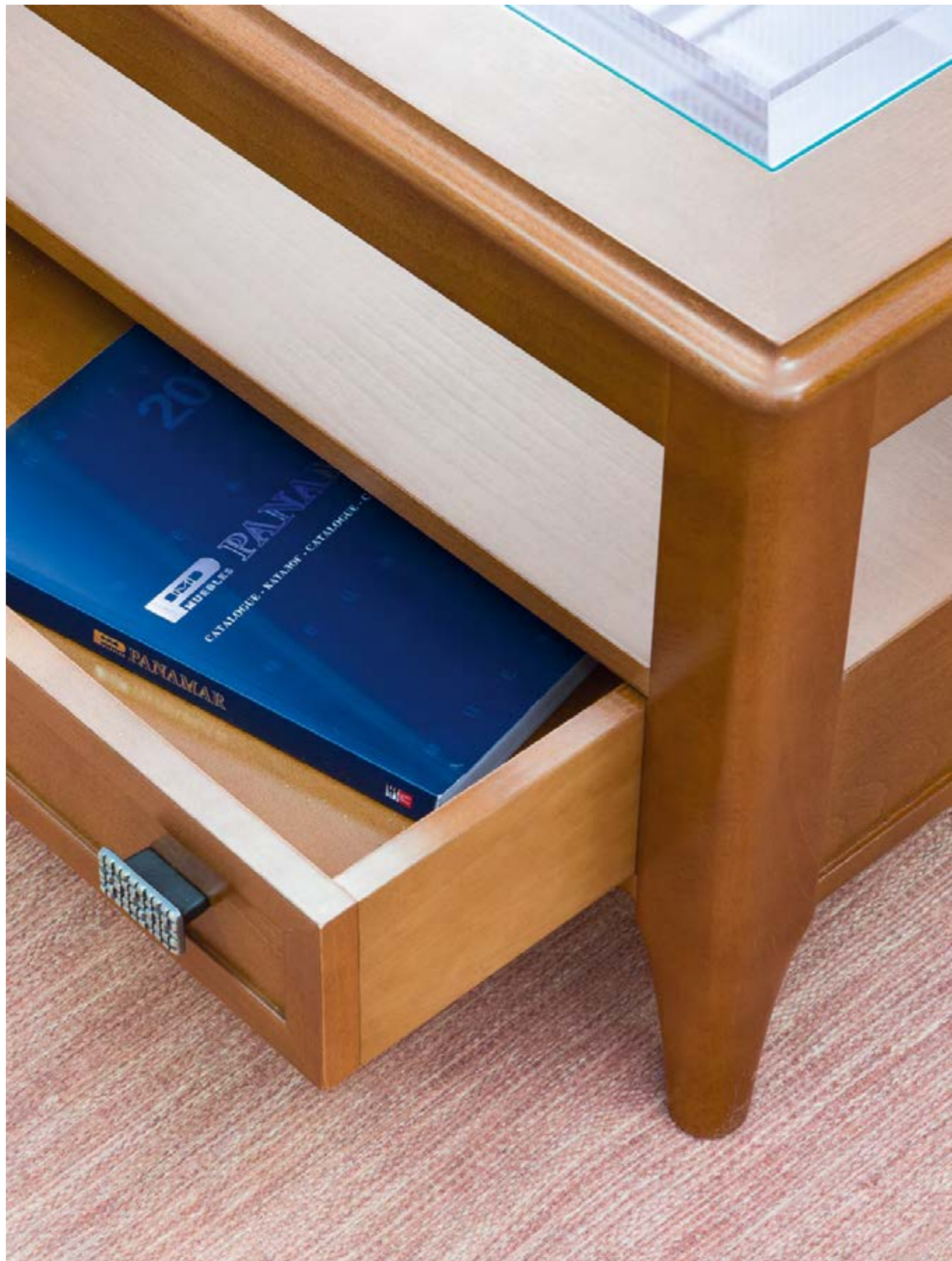

## COFFEE TABLES

mesas centro



**Las mesas de centro y rincón se fabrican con tapa de cristal.**

Coffee tables and corner tables are made with glass top.



SOFT AND ELEGANT LINES



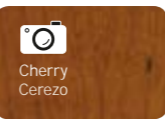
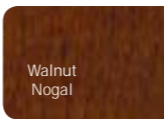
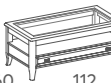
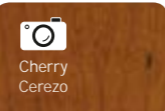
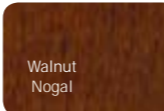





	MOD.					
 46 60 60	602.606 Corner table Mesa rincón	16,10	18 kg	0,20 m <sup>3</sup>	 Cherry Cerezo	 Walnut Nogal
 46 60 112	602.112 Coffee table Mesa centro	25,90	47 kg	0,36 m <sup>3</sup>	 Cherry Cerezo	 Walnut Nogal

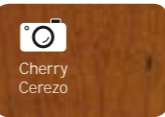
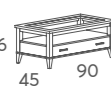

Las mesas de centro y rincón se fabrican con tapa de cristal.

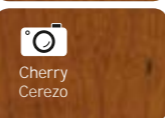
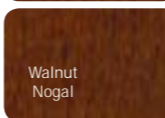
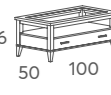
Coffee tables and corner tables are made with glass top.

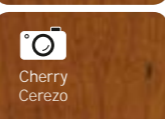

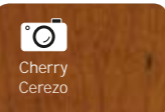
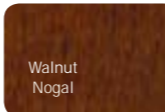
	MOD.					
	628.606 Corner table Mesa rincón	16,70	19 kg	0,19 m <sup>3</sup>		 
	628.090 Coffee table Mesa centro	22,20	29 kg	0,23 m <sup>3</sup>		 
	628.100 Coffee table Mesa centro	24,40	37 kg	0,28 m <sup>3</sup>		 
	628.112 Coffee table Mesa centro	26,60	47 kg	0,37 m <sup>3</sup>		 



Con materiales nobles como la madera maciza, creamos piezas solidas, robustas y prácticas

With noble materials such as solid wood, we create solid, robust and practical pieces



## worktop

METAL MECHANISM

Las mesas de centro y rincón se fabrican con tapa de cristal.

Coffee tables and corner tables are made with glass top.



	MOD.						
 46 60 60	637.606 Corner table Mesa rincón	17,80	14 kg	0,19 m <sup>3</sup>		 Cherry Cerezo	 Walnut Nogal
 46 50 100	636.100 Coffee table Mesa centro	25,60	30 kg	0,29 m <sup>3</sup>		 Cherry Cerezo	 Walnut Nogal
 46 60 112	636.112 Coffee table Mesa centro	28,00	37 kg	0,37 m <sup>3</sup>		 Cherry Cerezo	 Walnut Nogal
 46 100 100	636.101 Square table Mesa cuadrada	30,00	52 kg	0,53 m <sup>3</sup>		 Cherry Cerezo	 Walnut Nogal





Las mesas de centro y rincón se fabrican con tapa de cristal.  
Coffee tables and corner tables are made with glass top.



MOD.						
	<b>638.606</b> Corner table Mesa rincón	18,60	15 kg	0,19 m <sup>3</sup>		
	<b>638.112</b> Coffee table Mesa centro	23,80	25 kg	0,36 m <sup>3</sup>		
	<b>638.101</b> Square table Mesa cuadrada	25,50	31 kg	0,53 m <sup>3</sup>		



wonderful  
SHAPE YOUR STYLE



Las mesas de centro y rincón se fabrican con tapa de cristal.  
Coffee tables and corner tables are made with glass top.



MOD.						
	607.606 Corner table Mesa rincón	20,30	12 kg	0,19 m <sup>3</sup>		<div style="display: flex; justify-content: space-around;"> <div style="background-color: #8B4513; color: white; padding: 5px; text-align: center;">Cherry Cerezo</div> <div style="background-color: #4B3621; color: white; padding: 5px; text-align: center;">Walnut Nogal</div> </div>
	607.112 Coffee table Mesa centro	25,80	19 kg	0,37 m <sup>3</sup>		<div style="display: flex; justify-content: space-around;"> <div style="background-color: #8B4513; color: white; padding: 5px; text-align: center;">Cherry Cerezo</div> <div style="background-color: #4B3621; color: white; padding: 5px; text-align: center;">Walnut Nogal</div> </div>
	607.909 Coffee table Mesa centro	26,50	20 kg	0,44 m <sup>3</sup>		<div style="display: flex; justify-content: space-around;"> <div style="background-color: #8B4513; color: white; padding: 5px; text-align: center;">Cherry Cerezo</div> <div style="background-color: #4B3621; color: white; padding: 5px; text-align: center;">Walnut Nogal</div> </div>

# Estilo clásico donde se siente el trabajo artesanal

Classic style where craftsmanship is felt



Las mesas de centro y rincón se fabrican con tapa de cristal.

Coffee tables and corner tables are made with glass top.



	MOD.		kg	m <sup>3</sup>	
 43 60 60	606.606 Corner table Mesa rincón	16,40	14 kg	0,18 m <sup>3</sup>	 Cherry Cerezo  Walnut Nogal
 43 60 112	606.112 Coffee table Mesa centro	20,90	22 kg	0,32 m <sup>3</sup>	 Cherry Cerezo  Walnut Nogal
 43 90 90	606.909 Square table Mesa cuadrada	21,90	28 kg	0,38 m <sup>3</sup>	 Cherry Cerezo  Walnut Nogal



STYLISH AND CARVED COFFEE TABLES





**DINING TABLES**  
mesas comedor

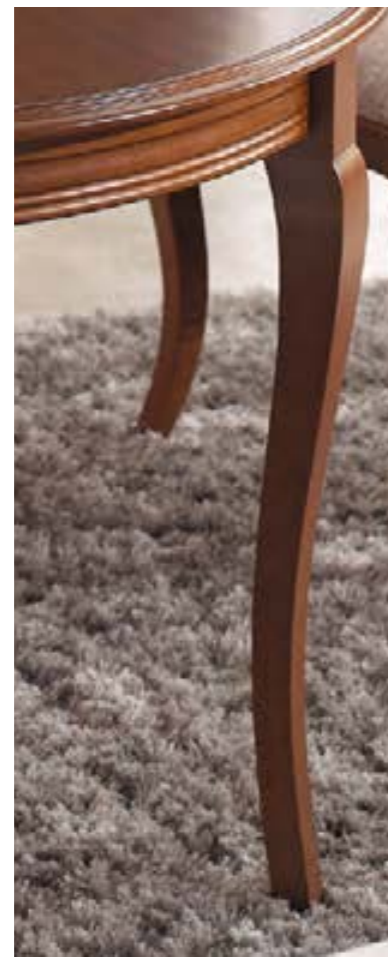

403

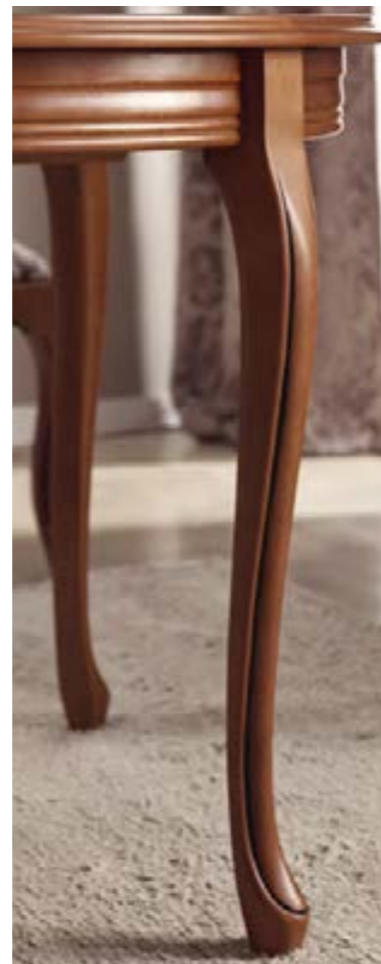

402

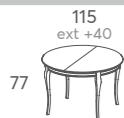

115  
ext +40



**403.115**  
Dining table  
Mesa



52,50



48 kg



0,21 m<sup>3</sup>

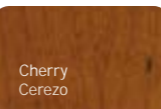

Cherry  
Cerezo

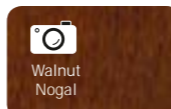

Walnut  
Nogal

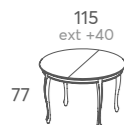

115  
ext +40

**402.115**  
Dining table  
Mesa

53,20

48 kg

0,21 m<sup>3</sup>

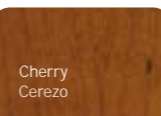

Cherry  
Cerezo

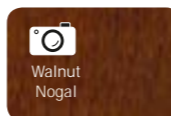

Walnut  
Nogal



TWO DIFFERENT FORMS OF CARVED LEGS



403

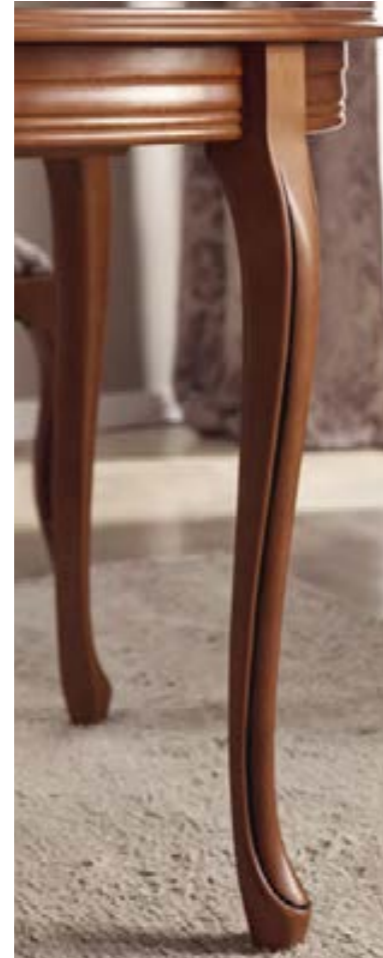

402



MOD.

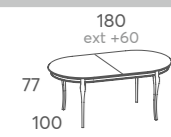

403.180  
Dining table  
Mesa

73,50

67 kg

0,28 m<sup>3</sup>

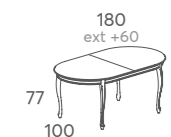

402.180  
Dining table  
Mesa

74,50

67 kg

0,28 m<sup>3</sup>

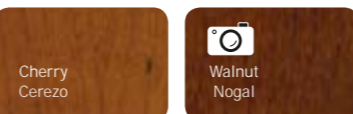

STYLISH AND THIN LEGS

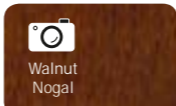
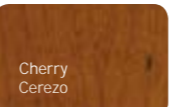

CARVED WOOD CENTRAL FOOT

	MOD.						
	161.090 Dining table Mesa	29,00	34 kg	0,34 m <sup>3</sup>	Fixed Fija		
	161.115 Dining table Mesa	31,00	40 kg	0,41 m <sup>3</sup>	Fixed Fija		
	401.115 Dining table Mesa	54,50	52 kg	0,41 m <sup>3</sup>	Extensible +40 cm.		
	401.180 Dining table Mesa	76,60	80 kg	0,72 m <sup>3</sup>	Extensible +60 cm.		



harmony  
SHAPE YOUR STYLE



**CHAIRS & ARMCHAIRS**  
sillas y sillones



FIESOLE 3

CURRENT AND FASHIONABLE DESIGN



MOD.



417.050  
Chair  
Silla

14,50

10 kg

0,17 m<sup>3</sup>

Note: Minimun order 2 pieces  
Nota: Pedido mínimo 2 unidades

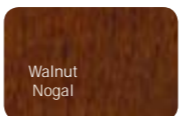
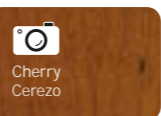

417.057  
Armchair  
Sillón

16,40

11 kg

0,34 m<sup>3</sup>

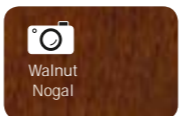
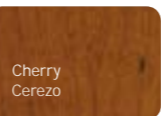

FIESOLE 3



FIESOLE 3

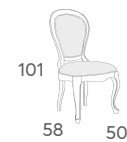

415.000  
Chair  
Silla

20,60

10 kg

0,17 m<sup>3</sup>

Note: Minimun order 2 pieces  
Nota: Pedido mínimo 2 unidades

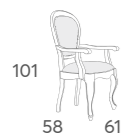
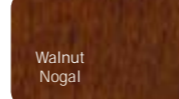
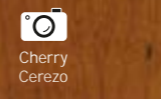

416.057  
Armchair  
Sillón

22,50

11 kg

0,34 m<sup>3</sup>

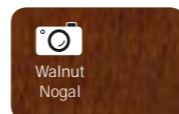
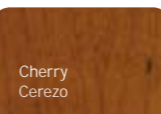

FIESOLE 4

STYLISH AND COMFORTABLE CHAIR



FIESOLE 3

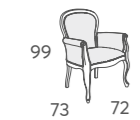

419.072  
Armchair  
Sillón

41,50

17 kg

0,49 m<sup>3</sup>

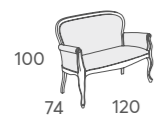

419.120  
Armchair  
Sillón

56,90

22 kg

0,85 m<sup>3</sup>

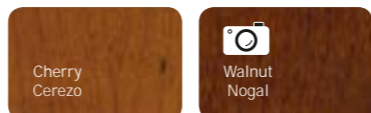

FIESOLE 3





FIESOLE 4

# elegance

REAL CAPITONE



MOD.

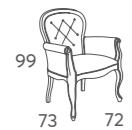

429.072  
Armchair  
Sillón

49,30

17 kg

0,49 m<sup>3</sup>

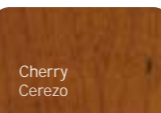

Cherry  
Cerezo

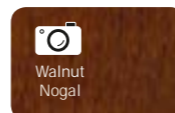

Walnut  
Nogal

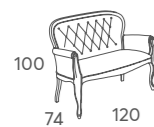

429.120  
Armchair  
Sillón

65,50

22 kg

0,85 m<sup>3</sup>

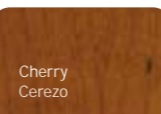

Cherry  
Cerezo

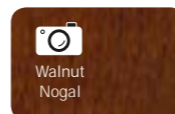

Walnut  
Nogal



TRADITIONAL CAPITONE

FIESOLE 4



FIESOLE 4

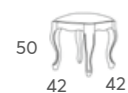

414.505  
Chair  
Banqueta

12,70

10 kg

0,11 m<sup>3</sup>

Cherry  
Cerezo



Walnut  
Nogal



414.100  
Chair  
Banqueta

14,30

12 kg

0,24 m<sup>3</sup>



Cherry  
Cerezo



Walnut  
Nogal



**Preciosa banqueta  
de patas talladas  
con curvas sutiles**

Beautiful bench with carved  
legs with subtle curves

FIESOLE 3



**SIDEBOARDS**  
aparadores



MOD.

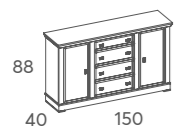

88  
40 150

231.150  
Sideboard  
Aparador

40,90

75 kg

0,60 m<sup>3</sup>

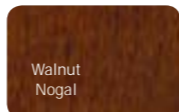
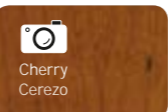

MOD.

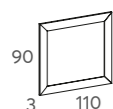

90  
3 110

302.110  
Mirror  
Marco

11,10

18 kg

0,06 m<sup>3</sup>

OTROS MODELOS PÁG. 70-71  
OTHER MODELS IN PAG. 70-71

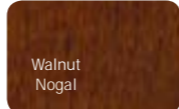
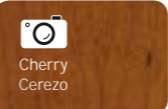

SOFT AND ELEGANT LINE



CURVED FRONT WITH MARQUETRY

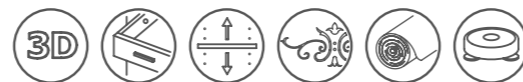

MOD.							
712.100 Hall cabinet-Shoes case Taquillón-Zapatero	32,70	38 kg	0,38 m <sup>3</sup>				

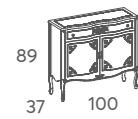

MOD.					<b>OTROS MODELOS PÁG. 70-71</b> <b>OTHER MODELS IN PAG. 70-71</b>			
316.080 Mirror Marco	14,50	14 kg	0,04 m <sup>3</sup>					

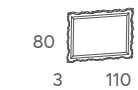



CURVED FRONT WITH MARQUETRY

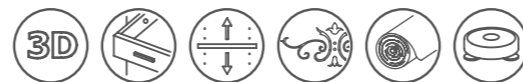

 89 38 140	731.140 Sideboard Aparador	41,80	54 kg	0,54 m <sup>3</sup>			



 80 3 110	316.080 Mirror Marco	14,50	14 kg	0,04 m <sup>3</sup>	OTROS MODELOS PÁG. 70-71 OTHER MODELS IN PAG. 70-71	





CURVED CENTRAL AREA

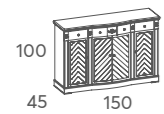

**831.150**  
Sideboard  
Aparador

57,00 81 kg 0,77 m<sup>3</sup>

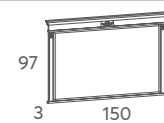
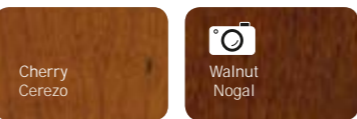

**823.150**  
Mirror  
Marco

19,20 23 kg 0,16 m<sup>3</sup>

OTROS MODELOS PÁG. 70-71  
OTHER MODELS IN PAG. 70-71

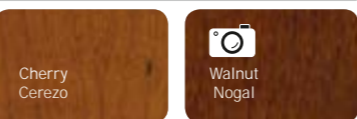

**essential**  
SHAPE YOUR STYLE





DISPLAY  
CABINETS

vitruinas



MOD.



140  
44 62

807.001  
Display cabinet  
Vitrina

31,50

55 kg

0,44 m<sup>3</sup>

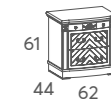
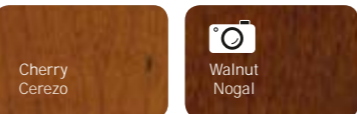
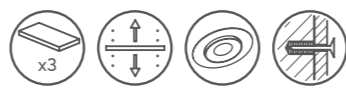

61  
44 62

837.000  
Module  
Módulo

20,00

28 kg

0,20 m<sup>3</sup>

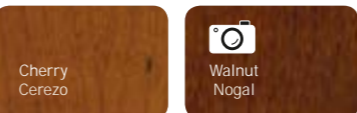

MOD.

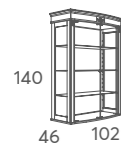

140  
46 102

805.001  
Display cabinet  
Vitrina

39,50

86 kg

0,75 m<sup>3</sup>

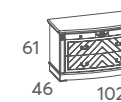
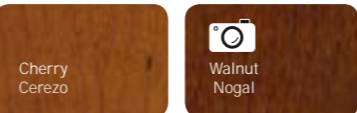
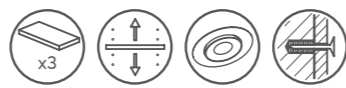

61  
46 102

835.000  
Module  
Módulo

27,30

41 kg

0,33 m<sup>3</sup>

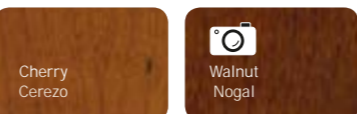

SOFT AND ELEGANT COLLECTION

distinction  
SHAPE YOUR STYLE



# sensational

## CURVED DISPLAY CABINET

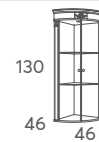
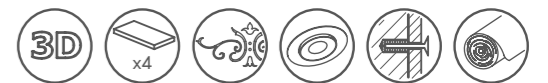

MOD.  
809.001  
Display cabinet  
Vitrina

30,90

46 kg

0,32 m<sup>3</sup>

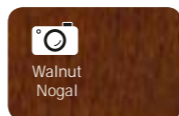
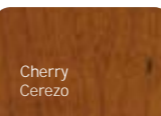

839.000  
Module  
Módulo

19,50

22 kg

0,18 m<sup>3</sup>

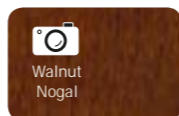
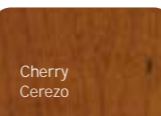

MOD.  
878.001  
Display cabinet  
Vitrina

33,00

60 kg

0,51 m<sup>3</sup>

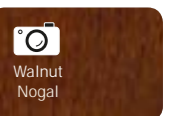
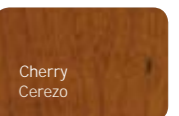



MOD.

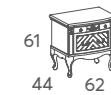
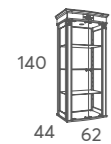

807.001  
Display cabinet  
Vitrina

31,50

55 kg

0,44 m<sup>3</sup>

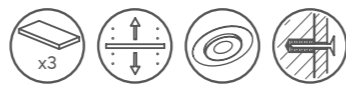

Cherry  
Cerezo



Walnut  
Nogal

MOD.

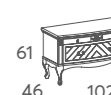

805.001  
Display cabinet  
Vitrina

39,50

86 kg

0,75 m<sup>3</sup>

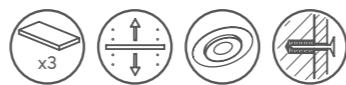

Cherry  
Cerezo



Walnut  
Nogal

MOD.



885.000  
Module  
Módulo

28,20

35 kg

0,33 m<sup>3</sup>



Cherry  
Cerezo



Walnut  
Nogal



DISPLAY CABINET LACQUERED WHITE

INDOOR LED SPOTLIGHT



MOD.

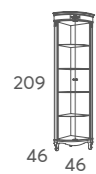

879.001  
Display cabinet  
Vitrina

34,20

60 kg

0,53 m<sup>3</sup>

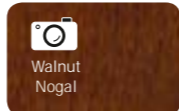
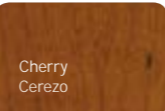



	MOD.		kg.	m <sup>3</sup>			
	809.001 Display cabinet Vitrina	30,90	46 kg	0,32 m <sup>3</sup>			
	889.000 Module Módulo	20,30	19 kg	0,18 m <sup>3</sup>			

**exceptional**  
FOR YOUR LIVING ROOM



BOOK  
CASES  
librerías

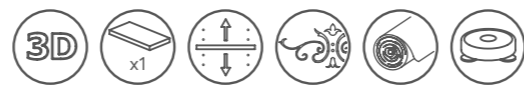

MOD.

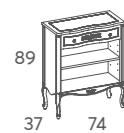

716.074  
Book case  
Librero

22,50

22 kg

0,29 m³

Cherry  
Cerezo



Walnut  
Nogal





MOD.



827.000  
Book case  
Librero

23,70

39 kg

0,44 m<sup>3</sup>

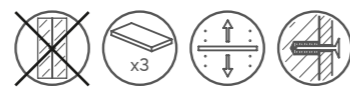

Cherry  
Cerezo

Walnut  
Nogal

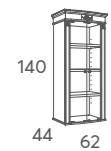

827.001  
Book case  
Librero

31,50

55 kg

0,44 m<sup>3</sup>

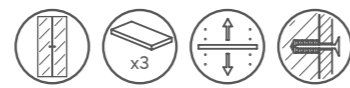

Cherry  
Cerezo

Walnut  
Nogal

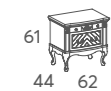

887.000  
Module  
Módulo

20,80

24 kg

0,20 m<sup>3</sup>



Cherry  
Cerezo

Walnut  
Nogal



	MOD.		kg.	m <sup>3</sup>	i		
 140 46 102	825.000	30,00	72 kg	0,75 m <sup>3</sup>		 Cherry Cerezo	 Walnut Nogal
 140 46 102	825.001	39,50	86 kg	0,75 m <sup>3</sup>		 Cherry Cerezo	 Walnut Nogal
 61 46 102	885.000	28,20	35 kg	0,33 m <sup>3</sup>		 Cherry Cerezo	 Walnut Nogal



## Mobiliario para tu oficina en casa, con puerta de cristal curvado opcional

Furniture for your home office, with optional curved glass door



	MOD.		kg.	m <sup>3</sup>			
	827.000	Book case	23,70	39 kg	0,44 m <sup>3</sup>		Cherry Cerezo Walnut Nogal
	827.001	Book case	31,50	55 kg	0,44 m <sup>3</sup>		Cherry Cerezo Walnut Nogal
	837.000	Module	20,00	28 kg	0,20 m <sup>3</sup>		Cherry Cerezo Walnut Nogal
	825.000	Book case	30,00	72 kg	0,75 m <sup>3</sup>		Cherry Cerezo Walnut Nogal
	825.001	Book case	39,50	86 kg	0,75 m <sup>3</sup>		Cherry Cerezo Walnut Nogal
	835.000	Module	27,30	41 kg	0,33 m <sup>3</sup>		Cherry Cerezo Walnut Nogal



HERRINGBONE CHERRY MARQUETRY

classical  
SHAPE YOUR STYLE



DESKS &  
VANITY TABLES  
escritorios y tocadores

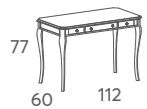

MOD.



767.112  
Desk  
Escritorio

29,30

30 kg

0,14 m<sup>3</sup>

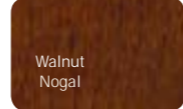
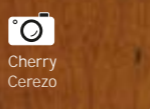

**outstanding**  
SHAPE YOUR STYLE



MOD.



30,50



30 kg



0,14 m<sup>3</sup>



768.112  
Desk  
Escritorio



Cherry  
Cerezo

Walnut  
Nogal



CURVED DOOR WITH LOCK



MOD.



kg.

m<sup>3</sup>

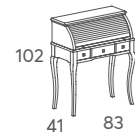
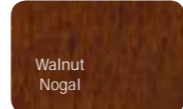
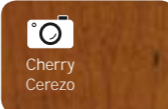

658.000  
Desk  
Secreter

35,50

39 kg

0,36 m<sup>3</sup>

**personal**  
YOUR HOME OFFICE



FINE HANDMADE MARQUETRY



MOD.

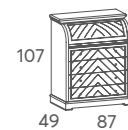

642.000  
Bureau  
Buró

47,30

67 kg

0,49 m³

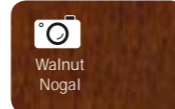
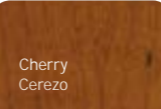

elegance  
SHAPE YOUR STYLE





## Un toque de exclusividad para tu habitación

A touch of exclusivity for your room



STYLISH VANITY TABLE

	MOD.								
 81 40 116	797.120 Vanity table Tocador	43,70	40 kg	0,30 m <sup>3</sup>	  	  	 Cherry Cerezo	 Walnut Nogal	
 101 58 50	415.000 Chair Silla	20,60	10 kg	0,17 m <sup>3</sup>	Note: Minimun order 2 pieces Nota: Pedido mínimo 2 unidades	 Cherry Cerezo	 Walnut Nogal		



MOD.

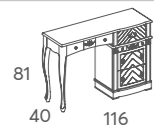

732.120  
Vanity table  
Tocador

43,50

48 kg

0,30 m<sup>3</sup>

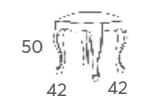
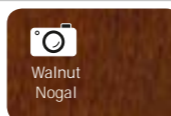
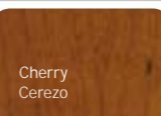

414.505  
Chair  
Banqueta

12,70

10 kg

0,11 m<sup>3</sup>

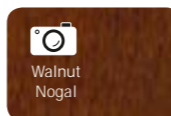
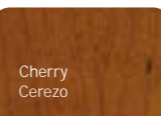

## CHESTS OF DRAWERS & BEDSIDE TABLES

cómodas y mesitas



MOD.

505.080  
Chest of drawers  
Sinfonier

34,90 69 kg 0,56 m<sup>3</sup>



						3D		
	MOD.							
	505.115 Chest of drawers CÓMODA	39,00	88 kg	0,77 m <sup>3</sup>				
111 52 115							Cherry Cerezo	Walnut Nogal
						3D		
	MOD.							
	316.080 Mirror Marco	14,50	14 kg	0,04 m <sup>3</sup>				
80 3 110							Cherry Cerezo	Walnut Nogal

OTROS MODELOS PÁG. 70-71  
OTHER MODELS IN PAG. 70-71



Detalle acabado cerezo / Detail cherry finished

## El estilo contemporáneo aporta elegancia y calidez a la estancia

The contemporary style brings elegance and warmth to the stay



SOFT AND ELEGANT CHEST OF DRAWERS

	MOD.							
108 46 102	511.100 Chest of drawers CÓMODA	33,90	69 kg	0,58 m <sup>3</sup>	Cherry Cerezo	Walnut Nogal	3D	
	MOD.							
110 4 80	308.110 Mirror Marco	15,00	12 kg	0,07 m <sup>3</sup>	Cherry Cerezo	Walnut Nogal	3D	OTROS MODELOS PÁG. 70-71 OTHER MODELS IN PAG. 70-71



MOD.	Ø	kg.	m <sup>3</sup>	i	Material
 89 37 74	714.074	30,00	31 kg	0,29 m <sup>3</sup>	Cherry Cerezo Walnut Nogal



MOD.	Ø	kg.	m <sup>3</sup>	i	Material
 110 4 80	308.110	15,00	12 kg	0,07 m <sup>3</sup>	Cherry Cerezo Walnut Nogal

OTROS MODELOS PÁG. 70-71  
OTHER MODELS IN PAG. 70-71





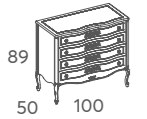
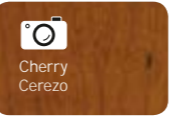
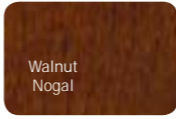

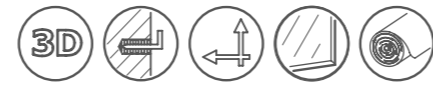
	MOD.		kg.	m <sup>3</sup>		
 89 50 100	714.100	Chest of drawers CÓMODA	38,00	48 kg	0,51 m <sup>3</sup>	 Cherry Cerezo  Walnut Nogal

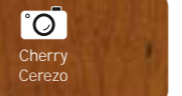

	MOD.		kg.	m <sup>3</sup>		
 80 3 110	316.080	Mirror MARCO	14,50	14 kg	0,04 m <sup>3</sup>	 Cherry Cerezo  Walnut Nogal

OTROS MODELOS PÁG. 70-71  
OTHER MODELS IN PAG. 70-71

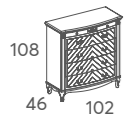
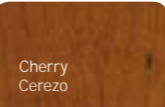

	MOD.						
	816.000	38,50	63 kg	0,56 m <sup>3</sup>			
108 46 102	Chest of drawers CÓMODA						

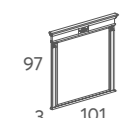
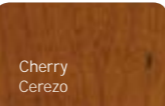
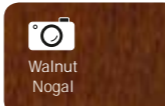

	MOD.						
	822.000	13,50	20 kg	0,06 m <sup>3</sup>			
97 3 101	Mirror MARCO						

OTROS MODELOS PÁG. 70-71  
OTHER MODELS IN PAG. 70-71



elegance  
SHAPE YOUR STYLE





Detalle acabado cerezo / Detail cherry finished

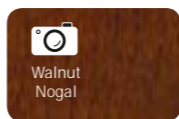
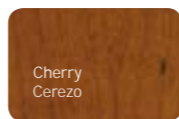
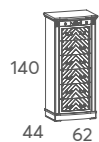

815.000  
Chest of drawers  
Sinfonier

34,20

55 kg

0,45 m<sup>3</sup>

Cherry  
Cerezo









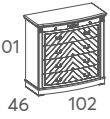

Walnut  
Nogal

140  
44 62

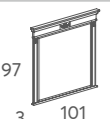

Walnut  
Nogal



	MOD.						
 101 46 102	814.000 Chest of drawers CÓMODA	37,00	59 kg	0,53 m <sup>3</sup>	 x5	  	<div style="display: flex; justify-content: space-around;"> <div style="background-color: #8B4513; color: white; padding: 5px; text-align: center;">Cherry Cerezo</div> <div style="background-color: #4B3621; color: white; padding: 5px; text-align: center;">Walnut Nogal</div> </div>
 97 3 101	822.000 Mirror Marco	13,50	20 kg	0,06 m <sup>3</sup>	    	<div style="display: flex; justify-content: space-around;"> <div style="background-color: #8B4513; color: white; padding: 5px; text-align: center;">Cherry Cerezo</div> <div style="background-color: #4B3621; color: white; padding: 5px; text-align: center;">Walnut Nogal</div> </div>	

OTROS MODELOS PÁG. 70-71  
OTHER MODELS IN PAG. 70-71



## Mobiliario que aporta la calidez perfecta para tu hogar

Furniture that provides the perfect warmth for your home

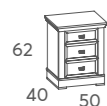

MOD.

501.050  
Bedside table  
Mesita noche



15,40



27 kg



0,15 m<sup>3</sup>



Cherry  
Cerezo

Walnut  
Nogal

# Mesita de noche con marquetería hecha a mano en los cajones y la tapa

Bedside table with handmade marquetry in drawers and top



CURVED AND CARVED FURNITURE



MOD.



59  
37 52

737.052  
Bedside table  
Mesita noche

21,50

15 kg

0,14 m<sup>3</sup>

Cherry  
Cerezo

Walnut  
Nogal

**delicate**  
SHAPE YOUR STYLE

## Mobiliario con detalles refinados y curvas en el frente

Furniture with refined details and curves in the front

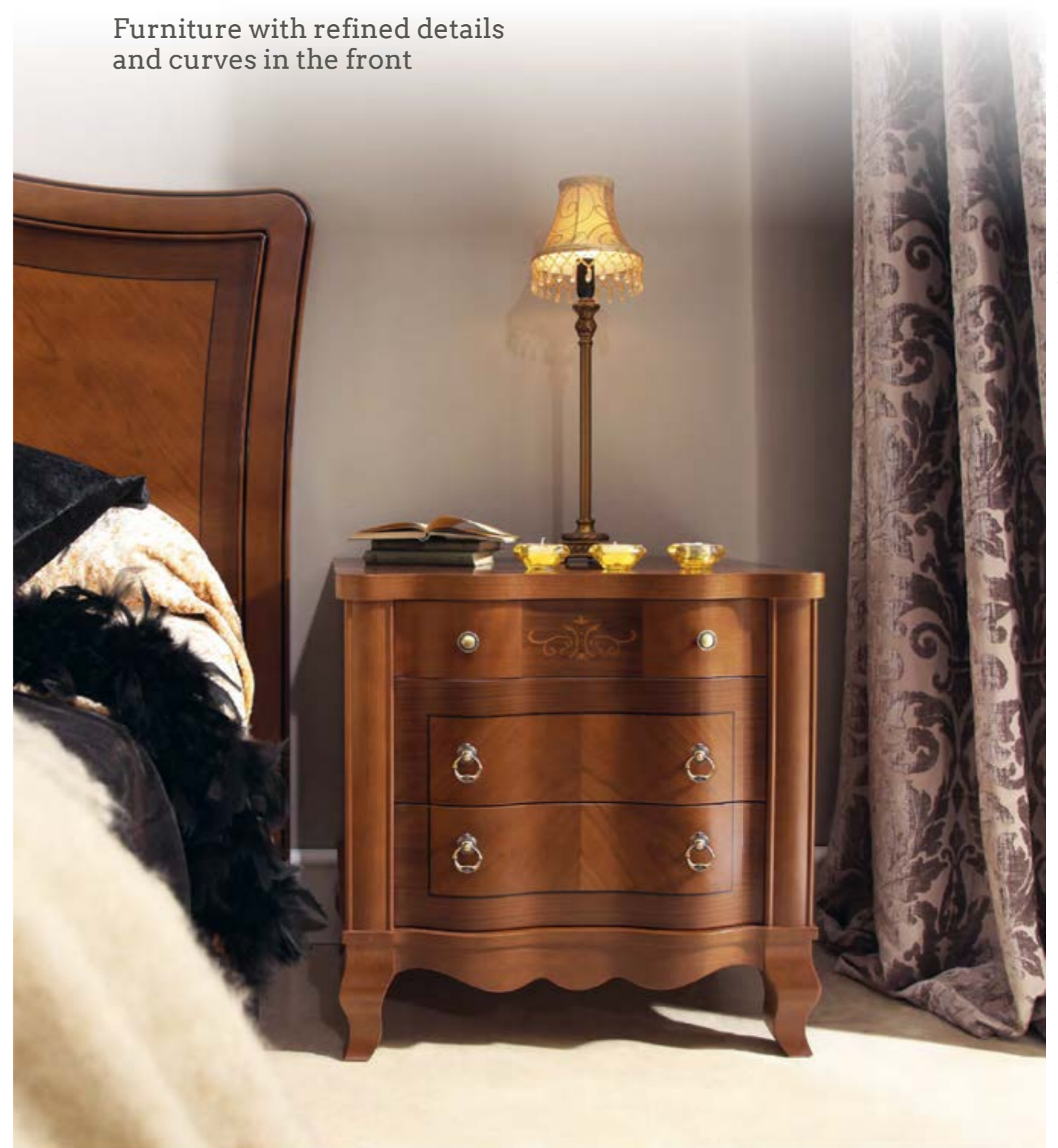

SOFT AND ELEGANT FURNITURE



MOD.



61  
45 60

505.060  
Bedside table  
Mesita noche

20,60

28 kg

0,18 m<sup>3</sup>

Cherry  
Cerezo

Walnut  
Nogal

# El trabajo artesanal se refleja en cada detalle

The artisan work is felt in every detail



DAINTY HANDMADE MARQUETRY



MOD.

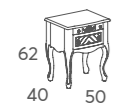

897.050  
Bedside table  
Mesita noche

18,80 18 kg 0,16 m<sup>3</sup>

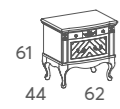
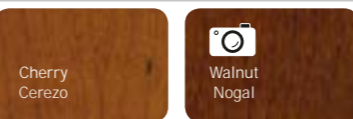

887.000  
Bedside table  
Mesita noche

20,80 24 kg 0,20 m<sup>3</sup>

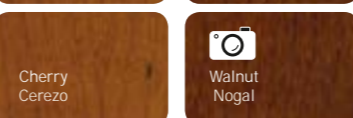

885.000  
Module  
Módulo

28,20 35 kg 0,33 m<sup>3</sup>

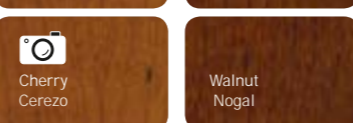

classical  
SHAPE YOUR STYLE



MOD.					
------	--	--	--	--	--

62  
40 51  
832.050  
Bedside table  
Mesita noche  
18,50 25 kg 0,16 m<sup>3</sup>

61  
44 62  
837.000  
Bedside table  
Mesita noche  
20,00 28 kg 0,20 m<sup>3</sup>

61  
46 102  
835.000  
Module  
Módulo  
27,30 41 kg 0,33 m<sup>3</sup>

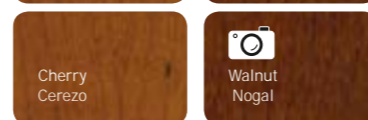
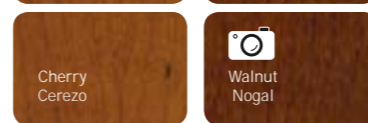
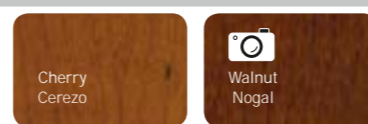



**BEDS &  
WARDROBES**  
camas y armarios





**Nota. El cabecero sin bañera, debe ser fijado a la pared.**  
 Note. The headboard without wooden frame must be fixed to the wall.



MOD.							
	870.135 Headboard Cabecero	30,00	154 cm	20 kg	0,16 m <sup>3</sup>	<input type="checkbox"/> Cherry Cerezo	<input type="checkbox"/> Walnut Nogal
	870.150 Headboard Cabecero	30,50	169 cm	22 kg	0,17 m <sup>3</sup>	<input type="checkbox"/> Cherry Cerezo	<input type="checkbox"/> Walnut Nogal
	870.160 Headboard Cabecero	31,00	179 cm	24 kg	0,18 m <sup>3</sup>	<input type="checkbox"/> Cherry Cerezo	<input type="checkbox"/> Walnut Nogal
	870.180 Headboard Cabecero	32,50	199 cm	27 kg	0,20 m <sup>3</sup>	<input type="checkbox"/> Cherry Cerezo	<input type="checkbox"/> Walnut Nogal

+ info pag. 194-199



**Nota. El cabecero sin bañera, debe ser fijado a la pared.**  
 Note. The headboard without wooden frame must be fixed to the wall.



MOD.							
	871.135 Headboard Cabecero	45,20	154 cm	20 kg	0,16 m <sup>3</sup>	<input type="checkbox"/> Cherry Cerezo	<input type="checkbox"/> Walnut Nogal
	871.150 Headboard Cabecero	46,70	169 cm	22 kg	0,17 m <sup>3</sup>	<input type="checkbox"/> Cherry Cerezo	<input type="checkbox"/> Walnut Nogal
	871.160 Headboard Cabecero	48,30	179 cm	24 kg	0,18 m <sup>3</sup>	<input type="checkbox"/> Cherry Cerezo	<input type="checkbox"/> Walnut Nogal
	871.180 Headboard Cabecero	52,00	199 cm	27 kg	0,20 m <sup>3</sup>	<input type="checkbox"/> Cherry Cerezo	<input type="checkbox"/> Walnut Nogal

+ info pag. 194-199

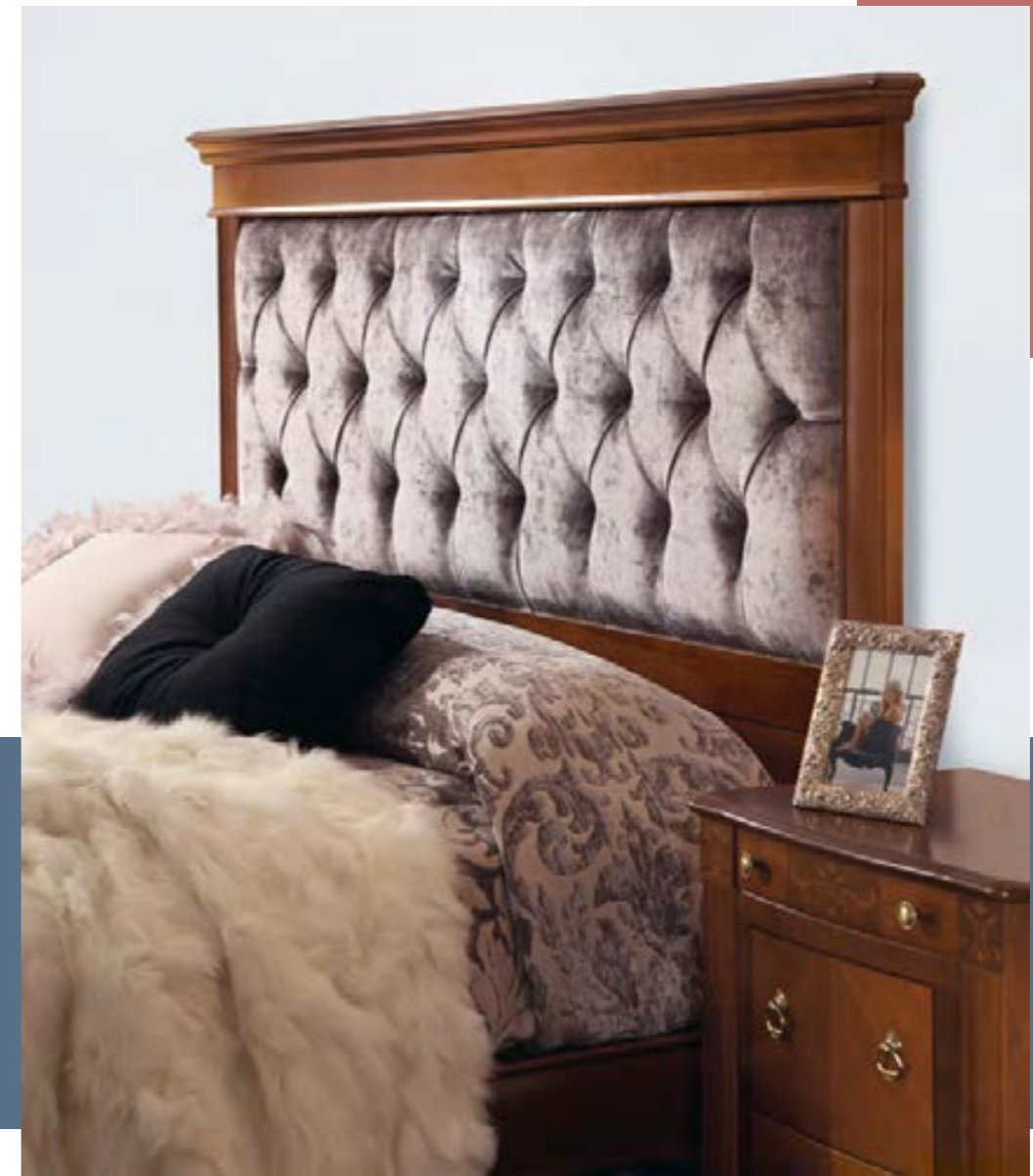

**Nota. El cabecero sin bañera, debe ser fijado a la pared.**

Note. The headboard without wooden frame must be fixed to the wall.



MOD.							
	810.135 Headboard Cabecero	24,90	154 cm	20 kg	0,23 m <sup>3</sup>		
	810.150 Headboard Cabecero	25,20	169 cm	24 kg	0,25 m <sup>3</sup>		
	810.160 Headboard Cabecero	26,00	179 cm	26 kg	0,26 m <sup>3</sup>		
	810.180 Headboard Cabecero	27,50	199 cm	29 kg	0,29 m <sup>3</sup>		

+ info pag. 194-199

**Nota. El cabecero sin bañera, debe ser fijado a la pared.**

Note. The headboard without wooden frame must be fixed to the wall.



MOD.							
	811.135 Headboard Cabecero	40,00	154 cm	20 kg	0,23 m <sup>3</sup>		
	811.150 Headboard Cabecero	41,50	169 cm	24 kg	0,25 m <sup>3</sup>		
	811.160 Headboard Cabecero	43,00	179 cm	26 kg	0,26 m <sup>3</sup>		
	811.180 Headboard Cabecero	46,20	199 cm	29 kg	0,29 m <sup>3</sup>		

+ info pag. 194-199

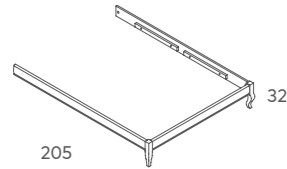

MOD.				kg.	m <sup>3</sup>		
450.135	Wooden frame	16,60	145 cm	16 kg	0,07 m <sup>3</sup>	Cherry Cerezo	Walnut Nogal
450.150	Wooden frame	16,70	160 cm	17 kg	0,07 m <sup>3</sup>	Cherry Cerezo	Walnut Nogal
450.160	Wooden frame	16,80	170 cm	17 kg	0,07 m <sup>3</sup>	Cherry Cerezo	Walnut Nogal
450.180	Wooden frame	17,40	190 cm	18 kg	0,07 m <sup>3</sup>	Cherry Cerezo	Walnut Nogal

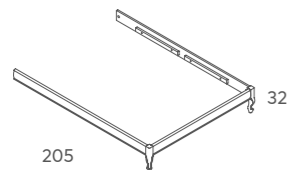

MOD.				kg.	m <sup>3</sup>		
451.135	Wooden frame	16,90	145 cm	16 kg	0,07 m <sup>3</sup>	Cherry Cerezo	Walnut Nogal
451.150	Wooden frame	17,00	160 cm	17 kg	0,07 m <sup>3</sup>	Cherry Cerezo	Walnut Nogal
451.160	Wooden frame	17,10	170 cm	17 kg	0,07 m <sup>3</sup>	Cherry Cerezo	Walnut Nogal
451.180	Wooden frame	17,70	190 cm	18 kg	0,07 m <sup>3</sup>	Cherry Cerezo	Walnut Nogal



MOD.				kg.	m <sup>3</sup>	
470.135	Spring frame	9,80	135 cm	24 kg	0,23 m <sup>3</sup>	x 78
470.150	Spring frame	9,80	150 cm	27 kg	0,25 m <sup>3</sup>	x 96
470.160	Spring frame	10,00	160 cm	28 kg	0,26 m <sup>3</sup>	x 96
470.180	Spring frame	10,50	180 cm	29 kg	0,30 m <sup>3</sup>	x 96

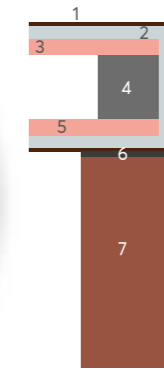
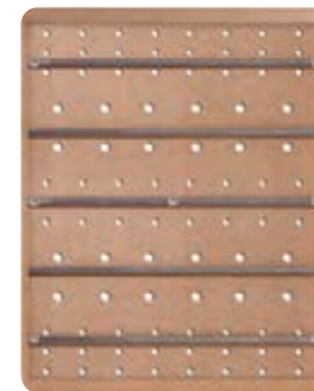
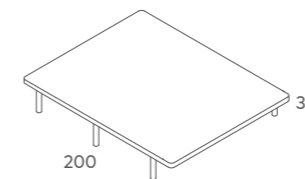

- 180 gr. 3D fabric with anti-slip treatment  
Tejido 3D de 180 gr. con tratamiento antideslizante
- 3D foam 6 mm polyurethane  
Poliuretano de 6 mm foamizado al 3D
- 7 mm multi-perforatedMDF with 5 ventilation zones  
MDF de 7 mm multiperforado con 5 zonas de ventilación
- Metal spring frame with 30x30x1 mm profile, with rounded corner adapted to the mattress  
Somier metálico con perfil de 30x03x1 mm, con esquina redondeada al colchón
- 7mm MDF stapled to metal  
MDF de 7 mm, grapado al metal
- Plastic washer / Arandela de plástico
- Metal leg / Pata metálica

## Canapé de madera natural

Natural wood storage bed



# Amplio canapé de madera natural, tapa abatible con ventilación inteligente y sistema de desplazamiento

Large natural wood storage bed, hinged top with intelligent ventilation and movement system.



	MOD.						
	460.135.200 Storage bed Canapé	28,50	135 cm	88 kg	0,36 m <sup>3</sup>	Cherry Cerezo	Walnut Nogal
	460.150.200 Storage bed Canapé	29,50	150 cm	90 kg	0,37 m <sup>3</sup>	Cherry Cerezo	Walnut Nogal
	460.160.200 Storage bed Canapé	32,60	160 cm	91 kg	0,40 m <sup>3</sup>	Cherry Cerezo	Walnut Nogal
	460.180.200 Storage bed Canapé	35,00	180 cm	94 kg	0,43 m <sup>3</sup>	Cherry Cerezo	Walnut Nogal



MOD.

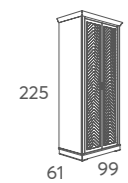

875.002  
Wardrobe  
Armario

69,00 125 kg 0,60 m<sup>3</sup>

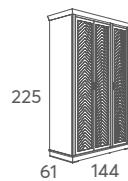
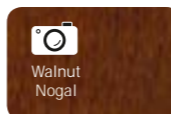
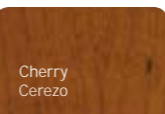

875.003  
Wardrobe  
Armario

91,00 180 kg 0,78 m<sup>3</sup>

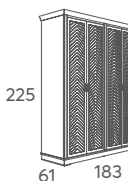
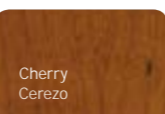
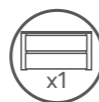

875.004  
Wardrobe  
Armario

107,40 223 kg 1,05 m<sup>3</sup>

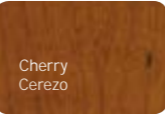
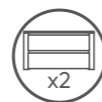

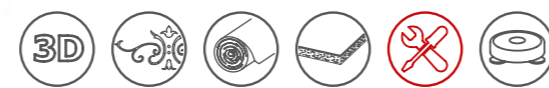

MOD.

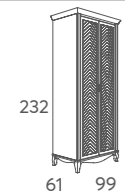

876.002  
Wardrobe  
Armario

72,50

125 kg

0,65 m<sup>3</sup>

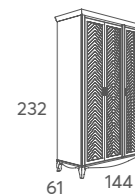
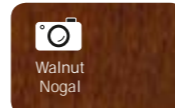
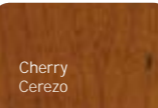

876.003  
Wardrobe  
Armario

95,00

180 kg

0,85 m<sup>3</sup>

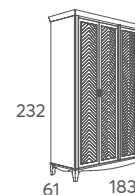
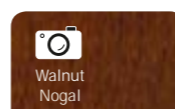
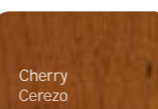
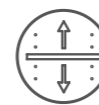
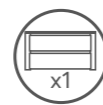

876.004  
Wardrobe  
Armario

111,20

223 kg

1,13 m<sup>3</sup>

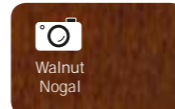
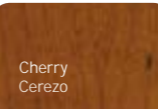



	<b>877.002</b> Wardrobe Armario	72,90	125 kg	0,65 m <sup>3</sup>		
	<b>877.003</b> Wardrobe Armario	95,40	180 kg	0,85 m <sup>3</sup>		
	<b>877.004</b> Wardrobe Armario	111,60	223 kg	1,13 m <sup>3</sup>		







3D model available  
Modelo disponible en 3D



Model with castors  
Modelo con ruedas



High quality drawers, with anti-turnover system  
Cajones de gran calidad, con sistema antivuelco



Metal lifting mechanism, long-lasting and built into the structure  
Mecanismo metálico elevable de gran fiabilidad, oculto en la estructura



Model with shelf  
Modelo con estante



Recessed and regulable LED spotlight, valid for 85-265 V AC 50/60HZ with switch, socket and two meters cable  
Foco LED regulable, válido para 85-265 V AC 50/60HZ con interruptor, enchufe y dos metros de cable



Adjustable shelf  
Estante regulable



Model with glass door  
Modelo con puerta de cristal



Optional: Patented metal pegs for boots storing  
Opcional: Exclusivas pinzas metálicas patentadas para la colocación de botas



Craftsmanship marquetry made of wood veneer  
Marquetería de chapa de madera hecha a mano



Exclusive metal folding mechanism, high resistance  
Exclusivo mecanismo metálico de alta resistencia para zapateros



Made of wood and natural veneers  
Fabricado con madera y chapas naturales



Ergonomic placement system, consisting of metal rods  
Sistema ergonómico para zapatos, fabricado de varilla metálica



Interior made of melamine board  
Interior fabricado en tablero melamínico



Model with reversible door  
Modelo con puerta reversible



Requires assembly  
Requiere montaje



High quality edge beveled  
Canto de gran calidad biselado



Height checked with robot vacuum cleaner (8cm)  
Altura comprobada con robot aspirador (8cm)



The furniture needs to be fastened to the wall  
El mueble necesita ser sujetado a la pared



3D foam fabric  
Tela 3D foamizado



Model hanging on the wall  
Modelo colgado en la pared



Anti slip fabrics  
Tejido antideslizante



It can be placed horizontally and vertically  
Se puede colocar horizontal y vertical



Easy cleaning  
Facil limpieza



Metal hook to hang  
Gancho metálico para colgar



Multi-ventilation top  
Tapa multi-ventilación



Extendable bar for hanging  
Barra extensible para colgar



Top with interior multi-ventilation system 5 differentiated breathability zones  
Tapa con sistema de multiventilación interior con 5 zonas de transpiración diferenciadas

SIGNORIA 3



FIESOLE 3



SIGNORIA 4



FIESOLE 4



NOTE: Fabrics width 1,40 m • 2,80 points lineal/meter • Minimum 1 meter  
NOTA: Ancho metraje 1,40 m. • 2,80 puntos metro/lineal • Mínimo 1 metro lineal



Cherry / Cerezo



Walnut / Nogal

**La madera es un producto natural y vivo, con lo cual cada mueble conserva una inconfundible vida propia. Por esto hay que valorar como garantía de autenticidad cualquier posible cambio en las vetas de la misma o en la tonalidad de color.**

Wood is a natural product, that is why each furniture has its own life. Therefore we have to appreciate any possible difference of vein or coloring, as a guarantee of authenticity.

MODEL	PAGE
104.090	49
104.120	51
105.080	35
105.110	37
115.110	39
115.130	41
117.070	43
117.100	45
117.125	47
161.090	100
161.115	100
164.050	62
164.090	63
164.120	61
165.050	66
165.060	66
165.070	66
168.050	66
168.060	66
168.070	66
169.050	66
169.060	66
172.050	65
211.150	73
231.150	117
301.000	70
302.090	70
302.110	70
308.110	71
316.080	71
316.135	71
329.000	70
349.070	71
401.115	100
401.180	100
402.115	96
402.180	98
403.115	96
403.180	98
414.100	112
414.505	112
415.000	106
416.057	106
417.050	104
417.057	104
419.072	108
419.120	108
429.072	110
429.120	110
432.080	22
433.080	22
435.040	22
435.060	22
440.080	22
441.080	70
443.080	70
450.135	194

MODEL	PAGE
450.150	194
450.160	194
450.180	194
451.135	194
451.150	194
451.160	194
451.180	194
460.135	198
460.150	198
460.160	198
460.180	198
470.135	195
470.150	195
470.160	195
470.180	195
501.050	179
505.060	183
505.080	163
505.115	165
511.100	167
539.076	17
544.000	25
545.080	13
545.110	15
549.070	19
570.090	27
578.060	29
578.090	31
602.112	83
602.606	83
606.112	92
606.606	92
606.909	92
607.112	90
607.606	90
607.909	90
628.090	84
628.100	84
628.112	84
628.606	84
636.100	86
636.101	86
636.112	86
637.606	86
638.101	88
638.112	88
638.606	88
642.000	157
658.000	155
701.140	75
712.074	53
712.100	55
714.074	169
714.100	171
716.074	141
731.140	57
732.120	161

MODEL	PAGE
737.052	181
767.112	151
768.112	153
797.120	159
801.150	79
805.001	128
807.001	128
809.001	137
810.135	192
810.150	192
810.160	192
810.180	192
811.135	193
811.150	193
811.160	193
811.180	193
814.000	177
815.000	175
816.000	173
821.000	71
822.000	71
823.150	71
825.000	144
825.001	144
827.000	146
827.001	146
831.150	125
832.050	186
835.000	186
837.000	186
839.000	130
861.150	77
870.135	190
870.150	190
870.160	190
870.180	190
871.135	191
871.150	191
871.160	191
871.180	191
875.002	200
875.003	200
875.004	200
876.002	202
876.003	202
876.004	202
877.002	204
877.003	204
877.004	204
878.001	131
879.001	135
881.150	123
885.000	184
887.000	184
889.000	137
897.050	187



C/ Poeta Fco. Antonio Jiménez, 18 P.O. Box, 155 - Post code 30510 - YECLA (Murcia ) SPAIN  
Tels.: (+34) 968 79 11 50 - (+34) 968 79 14 89 - Mobile: (+34) 660 06 29 46 - Fax (+34) 968 79 36 26

Nacional: pedidos@panamarmuebles.com

International: export@panamarmuebles.com

[www.panamarmuebles.com](http://www.panamarmuebles.com)